

PAF-X-11-PC-A - March 20, 2018

Item # PAF-X-11-PC-A was discontinued on March 20, 2018. For informational purposes, this is a copy of the website content at that time and is valid only for the stated product.

FIBERPORT COLLIMATORS / COUPLERS

- ▶ **Ultrastable Micropositioning Alignment with Five Degrees of Freedom Plus Rotation Adjustment**
- ▶ **Usable with SM, MM, and PM Fiber**
- ▶ **Aspheric or Achromatic Lens**
- ▶ **Models Available for 350 nm - 5 μm**



For FC/PC and FC/APC Connectors



FC/APC Connector



SMA Connector



FiberPort Mounted on an HCP Post Mount



FiberPorts Sold with Hex Keys and Dust Caps

OVERVIEW

Features

- 5 Degrees of Freedom plus Rotational Adjustment
- Micropositioning Alignment for Collimation or Coupling
- FC/PC, FC/APC, and SMA Versions
 - FC/PC and FC/APC Versions Accept Both 2.1 mm Wide Key and 2.0 mm Narrow Key Connectors
 - SMA FiberPorts are Designed for SMA905 Connectors
- Available with Either an Aspheric or an Achromatic Lens
- Suitable for Single Mode, Multimode, and Polarization-Maintaining (PM) Fiber
- AR Coating Options for Visible, NIR, and MIR Wavelength Ranges (See *Selection Guide* Tab for Details)

Thorlabs' compact, ultrastable FiberPort micropositioners provide an easy-to-use platform for coupling light into and out of optical fibers. This device enables alignment to an FC/PC-, FC/APC-, or SMA-terminated fiber with six directional adjustments. The compact size, combined with the ultrastable alignment and locking mechanism (detailed in the *Operation* tab), makes the FiberPort an ideal solution for fiber coupling or collimation.

Five Degrees of Freedom (Plus Bulkhead Rotation)

While holding the connector and fiber stationary, the built-in lens can be aligned with five degrees of freedom: linear alignment of the lens in the X and



Click to Enlarge
 FiberPort on HCP Post Mount Used to Collimate Light from a Single Mode Fiber

Available FiberPort Types
FC/PC and FC/APC Connector, Achromatic Doublet Lens
FC/PC and FC/APC Connector, Aspheric Lens, EFL ≤ 7.5 mm
FC/PC Connector, Aspheric Lens, EFL ≥ 11 mm
FC/APC Connector, Aspheric Lens, EFL ≥ 11 mm
SMA Connector, Aspheric Lens, All Focal Lengths
FiberPort Mounts

Y, angular alignment for tip and tilt, and Z adjustment using the tip and tilt controls simultaneously (see the *Mechanism* tab for complete details and an illustration). The travel range of the aspheric lens in the X/Y and Z directions is ± 0.7 mm and ± 0.4 mm, respectively, with a resolution of 0.012" (0.32 mm) per revolution. The tip/tilt travel range is $\pm 4^\circ$ with a resolution of 1.32° (23 mrad) per revolution. In addition, the locking screws on the front plate can be loosened to enable rotation of the bulkhead for PM fiber alignment. After alignment is complete, a locking setscrew can be tightened to secure the position. Please contact Tech Support for complete instructions regarding bulkhead adjustment.

Fiber Patch Cables for FiberPorts

We recommend using FiberPorts with our AR-coated single mode, multimode, or polarization-maintaining fiber optic patch cables for both coupling and collimating applications. These cables feature an antireflective coating on one fiber end for increased transmission and improved return loss at the fiber-to-free-space interface. These cables are available with an AR-coated FC/PC (SM and PM), FC/APC (SM and PM), or SMA (MM) connector. For FiberPorts being used in the mid-infrared spectral region, we recommend our fluoride fiber patch cables.

Mounting Options

FiberPorts contain four #2 counterbores that provide mechanical compatibility with our FiberBench accessories. We have also developed adapters for using FiberPorts with $\varnothing 1/2$ " posts, 30 mm cage systems, and HeNe lasers. Please see the *FiberPort Mounts* tab for more information.

SELECTION GUIDE

Lens Selection Example - Choosing a FiberPort for Fiber Coupling

The example presented here details the steps needed to ensure proper selection of a FiberPort to match the requirements of a particular fiber. For specific recommendations, please contact Technical Support.

Example:

- Wavelength: 633 nm
- Fiber: P1-630A-FC-2
- Collimated Beam Diameter Prior to Lens: $\varnothing 3$ mm

The specifications for the P1-630A-FC-2, 633 nm, FC/PC single mode patch cable indicate that the $1/e^2$ mode field diameter (MFD) is 4.3 μm at 633 nm. The MFD should equal the diffraction-limited spot size $\varnothing_{\text{spot}}$, which is given by the following equation:

$$\text{MFD} = \varnothing_{\text{spot}} = \frac{4\lambda f}{\pi D}, \text{ or } f = \frac{\pi D (\text{MFD})}{4\lambda}$$

Here, f is the focal length of the lens, λ is the wavelength of the input light, and D is the $1/e^2$ diameter of collimated beam incident on the lens. Solving for the desired focal length of the collimating lens yields:

$$f = \frac{\pi(0.003 \text{ m})(4.3 \times 10^{-6} \text{ m})}{4(633 \times 10^{-9} \text{ m})} = 0.016 \text{ m} = 16 \text{ mm}$$

Thorlabs offers a large selection of FiberPorts. You'll note that the FiberPort with a focal length closest to 16 mm has a focal length of 15.4 mm (Item # PAF-X-15-B), while also meeting the requirements for fiber connector type and antireflection coating range. This FiberPort also has a clear aperture that is larger than the collimated beam diameter. Therefore, this is the best option given the initial parameters (i.e., a P1-630A-FC-2 single mode fiber and a collimated beam diameter of 3 mm).

For optimum coupling, the spot size of the focused beam must be less than the MFD of the single mode fiber. As a result, if a FiberPort is not available that provides an exact match, then choose the FiberPort with a focal length that is shorter than the calculation above yields. Alternatively, if the clear aperture of the lens is large enough, the beam can be expanded before the lens, which has the result of reducing the spot size of the focused beam.

Please note that the NA values in the specification tables below are the numerical apertures of the lenses, not the required numerical aperture of the fiber you are using. As long as the lens NA is smaller than the NA of your fiber, you should be able to couple light. Please note that if your collimated beam diameter is smaller than the clear aperture of the lens you will need to recalculate the NA using the beam diameter. For best results, Thorlabs recommends using the equations above when choosing a FiberPort.

AR Coatings

The lenses in Thorlabs' FiberPorts use our A (350 - 700 nm, 400 - 600 nm, or 400 - 700 nm, depending upon the model; see the tables below), B (600 - 1050 nm), C (1050 - 1620 nm), D (1800 - 2400 nm), or E (2000 - 5000 nm) AR coatings. The plot below shows the typical per-surface reflectance of each AR coating. Each AR-coated lens is housed in a FiberPort package designed to be compatible with FC/PC-, FC/APC-, or SMA-terminated fibers. Care should be taken in selecting a FiberPort to make sure the correct fiber/connector/FiberPort combination is selected. AR-coating information and connector compatibility for each FiberPort are outlined in the tables below. If you need assistance, please contact your local tech support office.

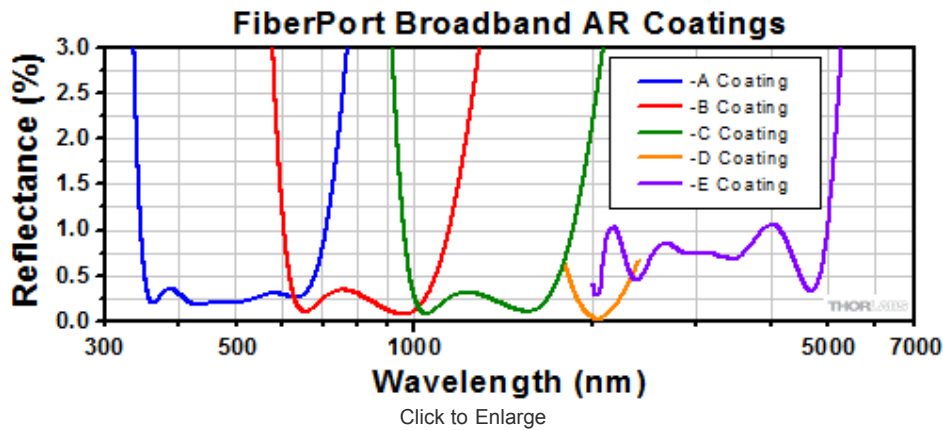

Aspheric vs. Achromatic FiberPort Performance

FiberPorts are available with either aspheric or achromatic doublet lenses. For applications requiring collimation of broadband light sources or multiple discrete wavelengths, the achromatic FiberPorts are ideal. The achromatic design of the PAFA series of FiberPorts utilizes cemented doublets, which are designed to minimize chromatic aberrations when coupling or collimating either a broadband light source or multiple discrete wavelengths. The small focal length shifts experienced by an achromatic doublet allow the FiberPort to be used over a broad wavelength range without needing realignment (see below).

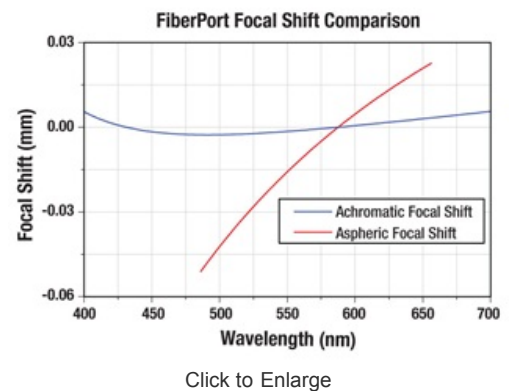
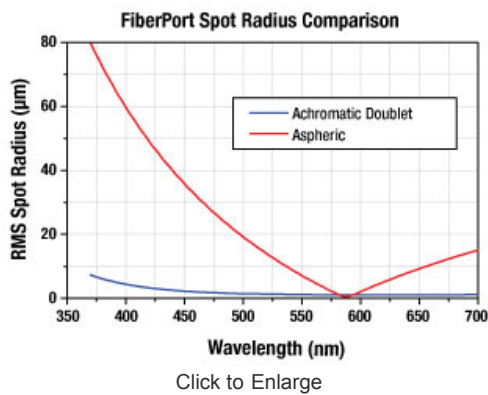

This graph compares the performance, with the lens at a fixed position, of an achromatic doublet to an aspheric lens when a collimated beam is focused onto a fiber, such as the case with our FiberPort couplers. The achromatic doublet provides a small spot size on the fiber over a large wavelength range, while the aspheric lens offers a small spot size only over a narrow range.

This graph plots the focal length shift of an aspheric lens (specifically, the aspheric lens in the PAF-X-5-A FiberPort) and an achromatic doublet with similar focal length (specifically, the aspheric lens in the PAFA-X-4-A FiberPort). The focal shift experienced by the aspheric lens over any given wavelength range is an order of magnitude larger than that of the achromatic doublet.

MECHANISM

The FiberPort is a six-degree-of-freedom fiber collimator and coupler (5 axes, plus rotation). It uses a movable lens as the alignment mechanism while holding the fiber stationary. This provides an extremely stable and repeatable platform for coupling and collimating. All adjustments are coupled.

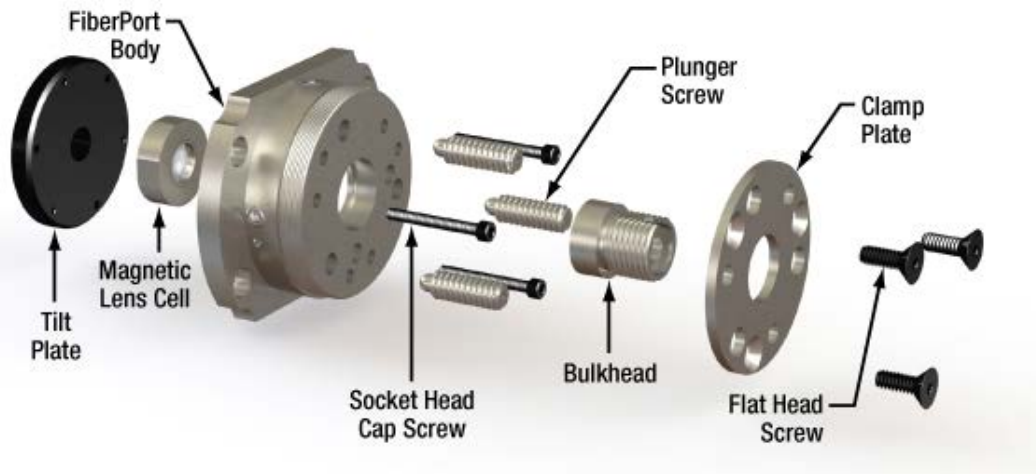

Click to Enlarge
Exploded View of FiberPort

The FiberPort consists of a body, a magnetic lens cell adhered to a tilt plate, and a bulkhead with fiber connector. The bulkhead is locked onto the FiberPort body by three flat head screws and the clamp plate. By loosening the flat head screws, the fiber bulkhead can be rotated freely.

Z/q/j Adjustment

The magnetic lens cell adheres to the tilt plate, which can be adjusted in Z/q/j (axial, tip, and tilt, respectively) using the three socket head cap screws. The plunger screws provide counterforce against the socket head cap screw. The q/j (tip/tilt) and Z (optical axis) translation range is $\pm 4^\circ$ and ± 0.4 mm, respectively, for a given position of the plunger screws. The tip/tilt and Z-axis resolution is 1.32° (23 mrad) and $0.012''$ (0.32 mm) per revolution, respectively. The plunger screws can translate the positive extreme of the travel range in the Z direction over a distance of 2 mm.

X-Y Adjustment

Additionally, the magnetic lens cell can be translated in X-Y using the socket head cap screws in the side of the FiberPort body. The magnetic lens cell rests on a leaf spring, and the X-Y screws push the cell against the leaf spring. A third socket head cap screw behind the leaf spring can be used for locking. The travel range of the aspheric lens in the X and Y directions is ± 0.7 mm, with a resolution of $0.012''$ (0.32 mm) per revolution, but when the FiberPort is used in a standard collimation/coupling application only a small portion of this translation range is used.

Location of Screws on the FiberPort

Please refer to the *Operation* tab for full operating instructions.

The X-Y lens adjustment screws are located on the outer diameter of the FiberPort body at the 9 o'clock and the 12 o'clock positions (shown in the photos to the right). The three plunger screws provide counterforce for the tilt plate. The three socket head cap screws provide the Z/q/j adjustments for the FiberPort. The three socket head cap screw and the X-Y screws are the only screws that are normally used in the alignment of the FiberPort, but the plunger screws can be used to adjust the tension on the tilt plate if needed. Also, the three flat head screws on the face of the FiberPort hold the clamp plate and bulkhead in place. By loosening these screws, the bulkhead can be rotated through a full 360° and secured at any angle for PM applications. This is a coarse adjustment, however.

The locking screw is located on the outer diameter of the FiberPort body at the 4:30 o'clock position. The locking screw is not installed when the FiberPort is shipped, but it is included in the package. The locking screw is only used after the FiberPort is aligned. NOTE: Locking is not necessary in most applications and tightening the locking screw may affect the coupling.

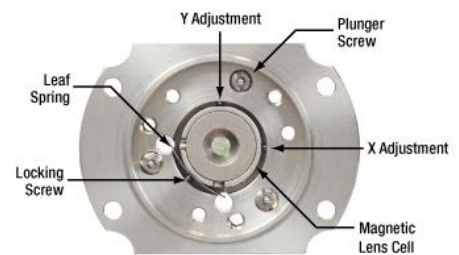

Click to Enlarge
FiberPort magnetic lens cell as Viewed from the Lens Side
(with Tilt Plate Removed)

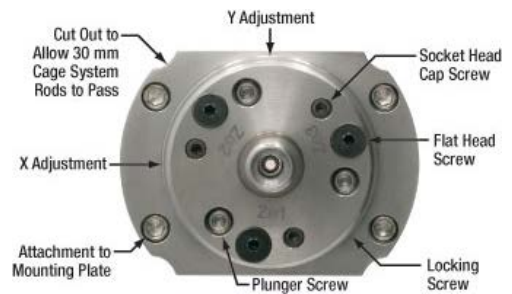

Click to Enlarge
Location of Adjustment and Mounting Screws as Viewed from
the Fiber Bulkhead Side

Part	Screw Size	Head Size (Hex)
Mounting Plate Attachment Screws	2-56	5/64" (2 mm)
X, Y, Z, Tip & Tilt Socket Head Screws	0-80	0.050" ^a

Flat Head Screws	2-56	0.050" ^a
Plunger Screws	6-32	0.035" ^a

- Hex keys in these sizes are shipped with each FiberPort.

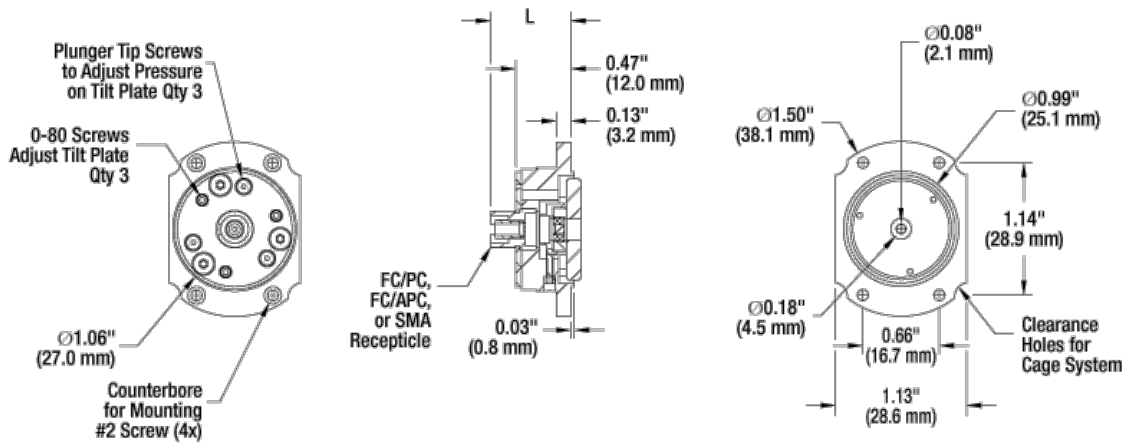

OPERATION

Collimating Out of a Fiber

- Attach a connectorized fiber source to the bulkhead of the FiberPort and examine the output.
- Adjust the X-Y screws to center the output beam in the tilt plate aperture. It is important to maintain the X-Y screws in a position neither too tight or loose at all times or they may not function properly.
- Trace the beam away from the FiberPort to check for collimation (see diagram to the right).
 - For a converging beam (beam comes to a focus): The lens is too far away from the fiber. Alternately turn the socket head cap screws clockwise in small, equal increments. **Be sure to adjust all screws in equal increments.**
 - For a diverging beam (beam diameter continually increases): The lens is too close to the fiber. Alternately turn the socket head cap screw counter clockwise in small, equal increments. **Be sure to adjust all screws in equal increments.**
- Check the beam path and adjust the X-Y screws as needed to re-center the beam in the output aperture.
- Use progressively smaller adjustments until collimation is achieved and the desired beam centration is obtained. Do not force the screws past their normal operating range. If collimation is not easily achieved, please contact Tech Support for assistance.

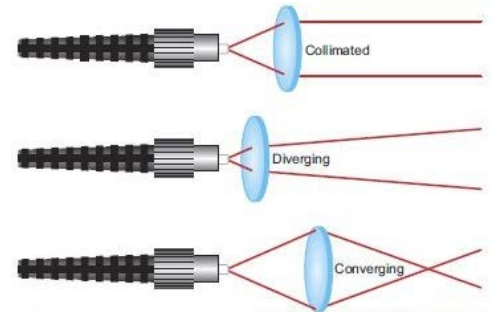

Click to Enlarge

Three Lens Positions: Collimated, Converging, and Diverging

Coupling into a Fiber

- If possible, collimate light out of the FiberPort first (see Collimating Out of a Fiber above). This will put the lens close to the correct position to start coupling.
- In order to launch a free-space beam into the FiberPort effectively, it is essential that the incoming beam path be aligned with the fiber axis of the FiberPort. The diagram to the right illustrates a simple technique that can be implemented to achieve this alignment.

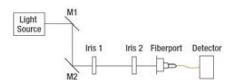

Click to Enlarge
FiberPort Alignment Setup

First, place two irises (set to the same height off the table) as shown in the figure to the right. Adjust mirror 1 (M1) until the beam passes through the center of Iris 1, then adjust M2 to align the beam through the center of Iris 2. Iris 1 may need to be opened at this stage to allow the beam to pass through to Iris 2 during the initial part of alignment. Repeat this process iteratively until the beam is centered through both Iris 1 and Iris 2.

- Place the FiberPort after Iris 2. Centering the input beam on the lens aperture of the FiberPort can be accomplished by affixing a target to the tilt plate in front of the lens. Make adjustments to the FiberPort's position until the beam is visibly centered on the FiberPort aperture. The FiberPort can be mounted on to a HCP bracket mount in order to adjust its position.

Once the beam is centered, light should be clearly visible exiting the back of the FiberPort (with no fiber attached). Move the FiberPort body to make sure the beam is not visually clipped.

4. Make sure the tip of the fiber is clean as this will maximize the amount of light coupled into the fiber. Once light is passing through the FiberPort, attach a multimode (MM) fiber ($\text{\O}50\ \mu\text{m}$ - $\text{\O}100\ \mu\text{m}$ core) to the FiberPort, which will make the initial alignment process easier rather than coupling directly into a single mode (SM) fiber.
5. Attach an optical detector to the end of the fiber not connected to the FiberPort and monitor the output signal. An optical detector has a faster response time than a power meter, and thus may be more helpful for FiberPort alignment. Steps 2 and 3 should ensure that enough light is coupled into the fiber in order to detect an output signal at this stage. If you do not have any measurable power, repeat steps 2 and 3.
6. Use the X and Y adjustment screws to maximize the output signal. These adjustments are extremely sensitive. Small adjustments here translate to large coupling changes. The X and Y adjustments are coupled, so finding the maximum signal is an iterative process between the X and Y adjustments. Once the XY maximum is achieved, only VERY SMALL adjustments are needed. It is important to maintain the X-Y screws in a position neither too tight or loose at all times, or they may not function properly.
7. Monitor and maximize the output signal while making small, **equal** adjustments in Z/q/j positioning socket head cap screws. This will allow the lens to move in the Z direction without altering the tip/tilt. **Be sure to adjust the socket head cap screw in equal increments.**

NOTE: In order to determine which way to adjust the screws, unscrew the fiber connector from the bulkhead and monitor the output as the fiber is retracted from the bulkhead. If the power increases, then the lens needs to move further away from the fiber, and if it decreases then the lens still has to move closer to the fiber. (Turn the SCHS clockwise to move the lens closer to the fiber, and counterclockwise to move the lens farther from the fiber.)

1. Start at any socket head cap screw on the face of the FiberPort and make very small adjustments to get a maximum in the output signal.
 2. Move in a clockwise or counterclockwise direction to the next socket head cap screw and make a similarly small adjustment.
 3. Continue in the same direction with the final socket head cap screw, and again make an equal adjustment.
 4. After adjusting the socket head cap screw, the signal may be lower than before the adjustment. Re-adjustment of the XY screws in the next step will show the increase in signal power.
8. Repeat step 6 (XY adjustment) to reach an absolute maximum signal. Note that adjusting the XY screws may involve losing the signal, and then finding the maximum again. Adjust the X and Y screws iteratively to find an absolute maximum.

As the coupling efficiency increases, the magnitude of the adjustments will get smaller and smaller. If you intend to couple into an SM fiber, switch the MM fiber to an SM fiber at this point (once there is good coupling into the MM fiber after steps 5 and 6). It will be necessary to repeat steps 6 - 8 with the SM fiber in place to maximize the coupling.

NOTE: When coupling into SM fiber, even the smallest adjustments can drastically affect the coupling. When adjusting the socket head cap screw, be aware that by simply monitoring the power of the output signal, one can get stuck in a local maxima and never achieve best coupling. The ideal procedure is to make a small EQUAL adjustment in each of the socket head cap screw in the chosen direction and only monitor the power once all the screws have been adjusted. Usually, one will see a drop in power when the second screw is adjusted, followed by a large increase in power either when the third screw is adjusted or when the XY screws are adjusted.

If you are using PM fiber, you can rotate the bulkhead to align the axis if needed. Please see the *Mechanism* tab above for more information on how to adjust the FiberPort.

FiberPort to FiberPort on a Single-Axis FiberBench

Rough Alignment

1. Assemble the FiberBench with both ports on the FiberBench facing each other as shown on the right.
2. Collimate beam from input FiberPort: Attach an optical fiber to the input FiberPort in order to launch light into the FiberBench. Adjust the three socket head cap screw screws in a near equal amount so the Z positioning is fine tuned to collimate the beam out of the fiber (see Collimating Out of a Fiber, above). It may only require very small adjustments.
3. Center beam on output FiberPort: Once good collimation is achieved, use slight (quarter or eighth) turns of the socket head cap screw to steer the beam to the center of the other FiberPort. If this adjustment is not enough, DO NOT adjust the screws any more. Instead, set them back to the previous position which gave good collimation (from step 2) and this time use the X-Y adjustment screws to move the lens in X-Y to steer the beam.
4. Collimate and center other FiberPort: Repeat steps 2 and 3 for the other FiberPort, launching light backward through the output fiber.
5. Beam Waist at Center: In order to maximize the coupling of light between the FiberPorts, place the waist of the beam at the center between the two FiberPorts.



Click to Enlarge
FiberPort to FiberPort on a Single-Axis FiberBench

Fine Tuning

1. Use multimode fiber for coarse alignment: To align the FiberBench, start with multimode ($\text{\O}50\ \mu\text{m}$ core - $\text{\O}100\ \mu\text{m}$ core) fiber on the output port. The large core allows for easy coupling and is good practice for the feel of the FiberPort and which types of adjustments translate to coupling. This also helps to understand how quickly one can go out of alignment. NOTE: It does not help to use multimode fiber on the input port.
2. Check output power: Connect the output fiber to a suitable detector in order to determine and monitor the power coupled into the output fiber, and the quality of the alignment. Some power should be present from steps 2 - 4 at this stage (possibly only 10 - 250 nW). If there is no measurable power, repeat steps 2 - 4 again.

3. Fine-tune coupling: Once you have a measurable signal from the output fiber, you can further improve and fine tune the alignment/coupling by making adjustments and monitoring the power level on the detector. See steps 6 - 8 in Coupling into a Fiber, above.
4. Switch to SM Fiber: Once the alignment is optimized, you can switch to using SM fiber on the output FiberPort. You may need to repeat step 3 to optimize the coupling efficiency.

Locking the FiberPort

Most applications **DO NOT** require locking.

If you are leaving the FiberPort on a table, it does not need to be locked. Typically, an aligned FiberPort can be hand carried and moved without alignment changes. Alignment can be lost in the locking process. For situations where the FiberPort can undergo large vibrations or shock, such as shipping, we recommend locking or potting the FiberPort. Locking the FiberPort is an iterative process that requires patience. The locking screw pushes the cell firmly against the X and Y screws. Alignment will be lost if the locking screw is tightened quickly.

When locking the position of the Magnetic Lens Cell using the procedure below, monitor the position of the beam if the FiberPort is being used as a collimator. If the FiberPort is being used to couple light into a fiber, attach a suitable optical detector to the output end of the fiber and monitor the output signal of the detector during the locking process. In either case, make sure that the locking process does not change the alignment of the Magnetic Lens Cell.

1. Carefully thread the small locking screw into the FiberPort at the 4:30 o'clock position on the outer diameter.
2. As you slowly tighten the locking screw, adjust the X-Y screws as required to maintain the alignment. **DO NOT TORQUE DOWN ANY OF THE SCREWS.** Applying too much pressure with the screws can permanently damage the magnet/lens assembly, the 0-80 screws, and/or destroy the alignment. When the X, Y, and locking screws are just snug, the lens is locked in place.
3. To prevent accidental changes in $Z/q/j$, carefully tighten the plunger screws with the 0.035" hex key. Make minor adjustments to the socket head cap screw as necessary to maintain the alignment of the Magnetic Lens Cell. **DO NOT TORQUE DOWN ANY OF THE SCREWS.**
4. If optimal alignment is lost when locking, first loosen the locking screw two full turns, then loosen the plunger screws one-quarter turn each. The less the plunger screws have to travel to be locked, the better. Now adjust the X-Y screws to regain optimal alignment. Repeat steps 2 and 3.

CALCULATIONS

Theoretical Approximation of the Divergence Angle

The full-angle beam divergence listed in the specifications tables is the theoretically-calculated value associated with the fiber collimator. This divergence angle is easy to approximate theoretically using the formula below as long as the light emerging from the fiber has a Gaussian intensity profile. Consequently, the formula works well for single mode fibers, but it will underestimate the divergence angle for multimode (MM) fibers since the light emerging from an MM fiber has a non-Gaussian intensity profile.

The Full Divergence Angle (in degrees) is given by

$$\theta \approx \left(\frac{[MFD]}{f} \right) \left(\frac{180}{\pi} \right)$$

where MFD is the mode field diameter and f is the focal length of the collimator. (Note: MFD and f must have the same units in this equation).

Example:

When the CFC-2X-A collimator is used with a single mode fiber patch cable such as our former item P1-460A-FC-2 such that $MFD = 3.3 \mu\text{m}$ and $f \approx 2.0 \text{ mm}$, the divergence angle is

$$\theta \approx (0.0033 \text{ mm} / 2.0 \text{ mm}) * (180/3.1416) \approx 0.095^\circ \text{ or } 1.66 \text{ mrad.}$$

Theoretical Approximation of the Output Beam Diameter

The output beam diameter can be approximated from

$$d = 4\lambda \left(\frac{f}{\pi[MFD]} \right)$$

where λ is the wavelength of light being used, MFD is the mode field diameter, and f is the focal length of the collimator.

Example:

When the CFC-5X-C collimator ($f = 4.6$ mm) is used with the P1-SMF28E-FC-1 patch cable ($MFD = 10.5$ μm) and 1550 nm light, the output beam diameter is

$$(4)(1550 \text{ nm})[4.6 \text{ mm} / (\pi \cdot 10.5 \mu\text{m})] = 0.87 \text{ mm}$$

Theoretical Approximation of the Maximum Waist Distance

The maximum waist distance, which is the furthest distance from the lens the waist can be located in order to maintain collimation, may be approximated by:

$$z_{max} = f + \frac{2f^2\lambda}{\pi[MFD]^2}$$





where f is the focal length of the collimator, λ is the wavelength of light used, and MFD is the mode field diameter.

Example:

When the CFC-2X-A collimator is used with a single mode fiber patch cable such as our former item P1-460A-FC-2 such that $MFD = 3.3$ μm , $f \approx 2.0$ mm, and $\lambda = 488$ nm, then the maximum waist distance is

$$(2 \text{ mm}) + (2 (2 \text{ mm})^2 (488 \text{ nm}) / (3.1416) (3.3 \mu\text{m})^2) = 116 \text{ mm}.$$

FIBERPORT MOUNTS

FiberPort Cage Mount		FiberPort Post Mount	
 <p>Click to Enlarge</p>	<p>The CP08FP FiberPort Cage Mount is designed to center a FiberPort inside a 30 mm cage system. The CP08FP secures to the four ER rods of a 30 mm cage assembly. Four included 2-56 stainless steel socket head screws secure a FiberPort to the adapter. The CP08FP has internal SM1 (1.035"-40) threading, enabling it to be used with our extensive line of Ø1" lens tubes, and also 8-32 or M4 taps for post mounting.</p>	 <p>Click to Enlarge</p>	<p>The HCP Post Mounting Bracket has four 2-56 threaded holes for securing a FiberPort to the front plate. The bottom of the L-bracket can be easily attached to an optical table, breadboard, or post, since it has 8-32- and M4-threaded holes, as well as a 1/4" (M6) counterbored hole.</p>
FiberPort Standard HeNe Adapter		FiberPort 5/8"-32 Threaded HeNe Adapter	
 <p>Click to Enlarge</p>	<p>The HCL HeNe to FiberPort Adapter attaches a FiberPort directly to the front of a HeNe laser with an industry-standard four-bolt pattern. For additional mounting options, the HCL features internal C-Mount (1.000"-32) threading, which is utilized on some lasers. All mounting screws are included. See Section 5.1 of the FiberPort manual (available as a PDF</p>	 <p>Click to Enlarge</p>	<p>The HCL2 Self-Contained HeNe to FiberPort Adapter, which features external 5/8"-32 threading, allows a FiberPort coupler to be attached directly to the threaded aperture of our self-contained HeNe lasers or any other 5/8"-32 tapped hole. A slip-plate design allows the position of the FiberPort to be shifted and locked to maximize coupling efficiency. FiberPort mounting screws are included. See</p>

here) for details.

Section 5.1 of the FiberPort manual (available as a PDF here) for details.

FiberPort and FiberBench











[Click to Enlarge](#)



Thorlabs' fiber-to-fiber U-Benches consist of a FiberBench base combined with two FiberPorts. The U-Benches allow for easy access to the optical beam and are ideal for fiber-to-fiber applications that incorporate multiple components and require the utmost in stability. Thorlabs offers a complete line of optical subassemblies that can be placed into the beam path. We also offer our FiberBenches bundled with two compatible FiberPorts.

COLLIMATOR GUIDE

Fiber Collimator Selection Guide

Click on the collimator type or photo to view more information about each type of collimator.

Type		Description
Fixed FC, APC, or SMA Fiber Collimators		These fiber collimation packages are pre-aligned to collimate light from an FC/PC-, FC/APC-, or SMA-terminated fiber. Each collimation package is factory aligned to provide diffraction-limited performance for wavelengths ranging from 405 nm to 4.55 μm . Although it is possible to use the collimator at detuned wavelengths, they will only perform optimally at the design wavelength due to chromatic aberration, which causes the effective focal length of the aspheric lens to have a wavelength dependence.
Air-Spaced Doublet, Large Beam Collimators		For large beam diameters ($\varnothing 6.6 - \varnothing 8.5$ mm), Thorlabs offers FC/PC, SMA, and FC/APC air-spaced doublet collimators. These collimation packages are pre-aligned at the factory to collimate a laser beam propagating from the tip of an FC or SMA-terminated fiber and provide diffraction-limited performance at the design wavelength.
Adjustable Fiber Collimators		These collimators are designed to connect onto the end of an FC/PC or FC/APC connector and contain an AR-coated aspheric lens. The distance between the aspheric lens and the tip of the FC-terminated fiber can be adjusted to compensate for focal length changes or to recollimate the beam at the wavelength and distance of interest.
Zoom Fiber Collimators		These collimators provide a variable focal length between 6 and 18 mm, while maintaining the collimation of the beam. As a result, the size of the beam can be changed without altering the collimation. This universal device saves time previously spent searching for the best suited fixed fiber collimator and has a very broad range of applications. They are offered with FC/PC, FC/APC, or SMA905 connectors with three different antireflection wavelength ranges to choose from.
Large Beam Fiber Collimators		Thorlabs' Large-Beam Fiber Collimators are designed with an effective focal length (EFL) of 40 mm or 80 mm over three different wavelength ranges and are available with FC/PC or FC/APC connectors. A four-element, air-spaced lens design produces a superior beam quality (M^2 close to 1) and less wavefront error when compared to aspheric lens collimators. As a result, these collimators are very flexible; they can be used as free-space collimator or coupler. They may also be used over a long distance in pairs, which allows the free-space beam to be manipulated prior to entering the second collimator and may be useful in long-distance communications applications.
FiberPorts		These compact, ultra-stable FiberPort micropositioners provide an easy-to-use, stable platform for coupling light into and out of FC/PC, FC/APC, or SMA terminated optical fibers. It can be used with single mode, multimode, or PM fibers and can be mounted onto a post, stage, platform, or laser. The built-in aspheric or achromatic lens is available with three different AR coatings and has five degrees of alignment adjustment (3 translational and 2 pitch). The compact size and long-term alignment stability make the FiberPort an ideal solution for fiber coupling, collimation, or incorporation into OEM systems.
Triplet Collimators		Thorlabs' High Quality Triplet Fiber Collimation packages use air-spaced triplet lenses that offer superior beam quality performance when compared to aspheric lens collimators. The benefits of the low-aberration triplet design include an M^2 term closer to 1 (Gaussian), less divergence, and less wavefront error.
Reflective Collimators		Thorlabs' metallic-coated Reflective Collimators are based on a 90° off-axis parabolic mirror. Mirrors, unlike lenses, have a focal length that remains constant over a broad wavelength range. Due to this intrinsic property, a parabolic mirror collimator does not need to be adjusted to accommodate various wavelengths of light, making them ideal for use with polychromatic light. Our reflective collimators are ideal for single-mode fiber.

Pigttailed Collimators		Our pigtailed collimators come with one meter of either single mode or multimode fiber, have the fiber and AR-coated aspheric lens rigidly potted inside the stainless steel housing, and are collimated at one of six wavelengths: 532, 830, 1030, 1064, 1310, or 1550 nm. Although it is possible to use the collimator at any wavelength within the coating range, the coupling loss will increase as the wavelength is detuned from the design wavelength.
GRIN Fiber Collimators		Thorlabs offers gradient index (GRIN) fiber collimators that are aligned at a variety of wavelengths from 630 to 1550 nm and have either FC terminated, APC terminated, or unterminated fibers. Our GRIN collimators feature a Ø1.8 mm clear aperture, are AR-coated to ensure low back reflection into the fiber, and are coupled to standard single mode or graded-index multimode fibers.
GRIN Lenses		These graded-index (GRIN) lenses are AR coated for applications at 630, 830, 1060, 1300, or 1560 nm that require light to propagate through one fiber, then through a free-space optical system, and finally back into another fiber. They are also useful for coupling light from laser diodes into fibers, coupling the output of a fiber into a detector, or collimating laser light. Our GRIN lenses are designed to be used with our Pigttailed Glass Ferrules and GRIN/Ferrule sleeves.

Achromatic FiberPorts for FC/PC and FC/APC Connectors (EFL = 4.0 mm)

- ▶ Achromatic Lens Collimates Over a Range of Wavelengths
- ▶ Small Focal Length Shift Over the Specified Wavelength Range
- ▶ Ideal for Laser-Based Fluorescence Experiments
- ▶ FC/PC- and FC/APC-Compatible

Our Achromatic FiberPorts collimate light over a large wavelength range with a very small focal length shift. The *Selection Guide* tab contains plots of the focal length shift for both the achromatic FiberPorts and similar aspheric FiberPorts. These FiberPorts can be used with both FC/PC and FC/APC connectors, as the FiberPort's 5-axis adjustment combined with its short focal length leads to negligible sensitivity to off-axis input.

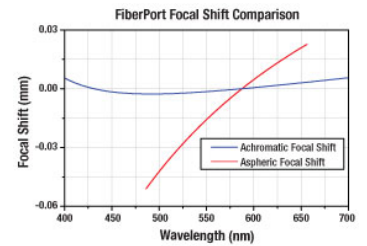

Click to Enlarge
Comparison of Focal Shifts in Achromatic and Aspheric FiberPorts
(400 - 700 nm Versions Shown)

Item #	EFL	Input MFD ^{a,b}	Output 1/e ² Waist Diameter ^a	Max Waist Distance ^{a,c}	Divergence ^a	EFL Shift ^{a,d}	Lens Characteristics				Length L ^g
							CA ^e	NA	AR Range ^f	Material	
PAFA-X-4-A	4.0 mm	3.5 μm	0.65 mm	378 mm	0.875 mrad	8.3 μm	1.8 mm	0.22	400 - 700 nm	N-SK16 / N-LASF9	0.69" (17.5 mm)
PAFA-X-4-B	4.0 mm	5.0 μm	0.87 mm	350 mm	1.250 mrad	6.9 μm	1.8 mm	0.22	650 - 1050 nm	N-LAK22 / N-SF6HT	0.69" (17.5 mm)
PAFA-X-4-C	4.0 mm	10.4 μm	0.76 mm	150 mm	2.600 mrad	14.8 μm	1.8 mm	0.22	1050 - 1620 nm	N-SF66 / N-LASF41	0.69" (17.5 mm)

- a. These values are calculated using the following equipment: -A: 460HP at 450 nm, -B: 780HP at 850 nm, -C: SMF-28e+ at 1550 nm
- b. Input Mode Field Diameter
- c. Maximum Waist Distance is defined as the maximum distance from the lens a Gaussian beam's waist can be placed.
- d. Focal length shift is specified over the entire AR coating wavelength range.
- e. Clear Aperture
- f. Wavelength range of the antireflection coating. See the *Selection Guide* tab for details.
- g. The length from the tip of the connector bulkhead to the face of the FiberPort flange, as shown in the diagram in the *Mechanism* tab.

Part Number	Description	Price	Availability
PAFA-X-4-A	Customer Inspired!Achromatic FiberPort, FC/PC & FC/APC, f = 4.00 mm, 400 - 700 nm, Ø0.65 mm Waist	\$536.52	3-5 Days
PAFA-X-4-B	Customer Inspired!Achromatic FiberPort, FC/PC & FC/APC, f = 4.00 mm, 650 - 1050 nm, Ø0.87 mm Waist	\$536.52	3-5 Days
PAFA-X-4-C	Customer Inspired!Achromatic FiberPort, FC/PC & FC/APC, f = 4.00 mm, 1050 - 1620 nm, Ø0.76 mm Waist	\$536.52	Today

Aspheric FiberPorts for FC/PC and FC/APC Connectors (EFL of 7.5 mm or Less)

Item # ^a	EFL	Input MFD ^{b,c}	Output $1/e^2$ Waist Diameter ^b	Max Waist Distance ^{b,d}	Divergence ^b	Lens Characteristics				Length L ^g
						CA ^e	NA	AR Range ^f	Material	
PAF-X-2-A	2.0 mm	3.5 μ m	0.33 mm	96 mm	1.750 mrad	2.0 mm	0.50	350 - 700 nm	ECO-550	0.65" (16.6 mm)
PAF-X-2-B	2.0 mm	5.0 μ m	0.43 mm	89 mm	2.500 mrad	2.0 mm	0.50	600 - 1050 nm	ECO-550	0.65" (16.6 mm)
PAF-X-2-C	2.0 mm	10.4 μ m	0.38 mm	38 mm	5.200 mrad	2.0 mm	0.50	1050 - 1620 nm	ECO-550	0.65" (16.6 mm)
PAF-X-4-E	4.0 mm	14.47 μ m	1.23 mm	169 mm	3.617 mrad	5.0 mm	0.56	2 - 5 μ m	Black Diamond-2	0.69" (17.5 mm)
PAF-X-5-A	4.6 mm	3.5 μ m	0.75 mm	499 mm	0.761 mrad	4.9 mm	0.47	350 - 700 nm	H-LAK54	0.69" (17.5 mm)
PAF-X-5-B	4.6 mm	5.0 μ m	1.00 mm	463 mm	1.087 mrad	4.9 mm	0.47	600 - 1050 nm	H-LAK54	0.69" (17.5 mm)
PAF-X-5-C	4.6 mm	10.4 μ m	0.87 mm	198 mm	2.261 mrad	4.9 mm	0.47	1050 - 1620 nm	H-LAK54	0.69" (17.5 mm)
PAF-X-5-D	4.6 mm	13 μ m	0.90 mm	164 mm	2.826 mrad	4.9 mm	0.47	1.8 - 2.4 μ m	H-LAK54	0.69" (17.5 mm)
PAF-X-7-A	7.5 mm	3.5 μ m	1.23 mm	1323 mm	0.467 mrad	4.4 mm	0.29	350 - 700 nm	H-LAK54	0.69" (17.5 mm)
PAF-X-7-B	7.5 mm	5.0 μ m	1.62 mm	1225 mm	0.667 mrad	4.4 mm	0.29	600 - 1050 nm	H-LAK54	0.69" (17.5 mm)
PAF-X-7-C	7.5 mm	10.4 μ m	1.42 mm	521 mm	1.387 mrad	4.4 mm	0.29	1050 - 1620 nm	H-LAK54	0.69" (17.5 mm)

- a. FiberPorts with an effective focal length of 7.5 mm or less can be used with both FC/PC and FC/APC connectors, as the 5-axis adjustment combined with the short focal length leads to a negligible off-axis output.
- b. These values are calculated using the following equipment: -A: 460HP at 450 nm, -B: 780HP at 850 nm, -C: SMF-28e+ at 1550 nm, -D: SM2000 at 2 μ m, E: ZrF₄ at 3.39 μ m
- c. Input Mode Field Diameter
- d. Maximum Waist Distance is defined as the maximum distance from the lens a Gaussian beam's waist can be placed.
- e. Clear Aperture
- f. Wavelength range of the antireflection coating. See the *Selection Guide* tab for details.
- g. The length from the tip of the connector bulkhead to the face of the FiberPort flange, as shown in the diagram in the *Mechanism* tab.

Part Number	Description	Price	Availability
PAF-X-2-A	FiberPort, FC/PC & FC/APC, f=2.0 mm, 350 - 700 nm, Ø0.33 mm Waist	\$502.86	Today
PAF-X-2-B	FiberPort, FC/PC & FC/APC, f=2.0 mm, 600 - 1050 nm, Ø0.43 mm Waist	\$502.86	Today
PAF-X-2-C	FiberPort, FC/PC & FC/APC, f=2.0 mm, 1050 - 1620 nm, Ø0.38 mm Waist	\$502.86	Today
PAF-X-4-E	Customer Inspired!FiberPort, FC/PC & FC/APC, f=4.0 mm, 2 - 5 μ m, Ø1.23 mm Waist	\$852.72	3-5 Days
PAF-X-5-A	FiberPort, FC/PC & FC/APC, f=4.6 mm, 350 - 700 nm, Ø0.75 mm Waist	\$459.00	3-5 Days
PAF-X-5-B	FiberPort, FC/PC & FC/APC, f=4.6 mm, 600 - 1050 nm, Ø1.00 mm Waist	\$459.00	3-5 Days
PAF-X-5-C	FiberPort, FC/PC & FC/APC, f=4.6 mm, 1050 - 1620 nm, Ø0.87 mm Waist	\$459.00	Today
PAF-X-5-D	Customer Inspired!FiberPort, FC/PC & FC/APC, f=4.6 mm, 1.8 - 2.4 μ m, Ø0.90 mm Waist	\$459.00	Today
PAF-X-7-A	FiberPort, FC/PC & FC/APC, f=7.5 mm, 350 - 700 nm, Ø1.23 mm Waist	\$459.00	Today
PAF-X-7-B	FiberPort, FC/PC & FC/APC, f=7.5 mm, 600 - 1050 nm, Ø1.62 mm Waist	\$459.00	Today
PAF-X-7-C	FiberPort, FC/PC & FC/APC, f=7.5 mm, 1050 - 1620 nm, Ø1.42 mm Waist	\$459.00	Today

Aspheric FiberPorts for FC/PC Connectors (EFL of 11 mm or Greater)

Item #	EFL	Input MFD ^{a,b}	Output $1/e^2$ Waist Diameter ^a	Max Waist Distance ^{a,c}	Divergence ^a	Lens Characteristics				Length L ^f
						CA ^d	NA	AR Range ^e	Material	
PAF-X-11-PC-A	11.0 mm	3.5 μ m	1.80 mm	2841 mm	0.318 mrad	4.4 mm	0.20	350 - 700 nm	H-LAK54	0.87" (22.0 mm)
PAF-X-11-PC-B	11.0 mm	5.0 μ m	2.38 mm	2630 mm	0.455 mrad	4.4 mm	0.20	600 - 1050 nm	H-LAK54	0.87" (22.0 mm)
PAF-X-11-PC-C	11.0 mm	10.4 μ m	2.09 mm	1115 mm	0.945 mrad	4.4 mm	0.20	1050 - 1620 nm	H-LAK54	0.87" (22.0 mm)
PAF-X-11-PC-D	11.0 mm	13 μ m	2.15 mm	923 mm	1.182 mrad	4.4 mm	0.20	1.8 - 2.4 μ m	H-LAK54	0.87" (22.0 mm)
PAF-X-11-PC-E	11.0 mm	14.47 μ m	3.39 mm	1258 mm	1.315 mrad	4.0 mm	0.18	2 - 5 μ m	Black Diamond-2	0.87" (22.0 mm)
PAF-X-15-PC-A	15.4 mm	3.5 μ m	2.52 mm	5562 mm	0.227 mrad	5.0 mm	0.16	350 - 700 nm	ECO-550	0.87" (22.0 mm)

PAF-X-15-PC-B	15.4 mm	5.0 µm	3.33 mm	5149 mm	0.325 mrad	5.0 mm	0.16	600 - 1050 nm	ECO-550	0.87" (22.0 mm)
PAF-X-15-PC-C	15.4 mm	10.4 µm	2.92 mm	2179 mm	0.675 mrad	5.0 mm	0.16	1050 - 1620 nm	ECO-550	0.87" (22.0 mm)
PAF-X-15-PC-D	15.4 mm	13 µm	3.02 mm	1802 mm	0.844 mrad	5.0 mm	0.16	1.8 - 2.4 µm	ECO-550	0.87" (22.0 mm)
PAF-X-18-PC-A	18.4 mm	3.5 µm	3.01 mm	8936 mm	0.190 mrad	5.5 mm	0.15	350 - 700 nm	ECO-550	0.69" (17.5 mm)
PAF-X-18-PC-B	18.4 mm	5.0 µm	3.98 mm	7347 mm	0.272 mrad	5.5 mm	0.15	600 - 1050 nm	ECO-550	0.69" (17.5 mm)
PAF-X-18-PC-C	18.4 mm	10.4 µm	3.49 mm	3107 mm	0.565 mrad	5.5 mm	0.15	1050 - 1620 nm	ECO-550	0.69" (17.5 mm)
PAF-X-18-PC-D	18.4 mm	13 µm	3.60 mm	2569 mm	0.707 mrad	5.5 mm	0.15	1.8 - 2.4 µm	ECO-550	0.69" (17.5 mm)

- a. These values are calculated using the following equipment: -A: 460HP at 450 nm, -B: 780HP at 850 nm, -C: SMF-28e+ at 1550 nm, -D: SM2000 at 2 µm, -E: ZrF₄ at 3.39 µm
- b. Input Mode Field Diameter
- c. Maximum Waist Distance is defined as the maximum distance from the lens a Gaussian beam's waist can be placed.
- d. Clear Aperture
- e. Wavelength range of the antireflection coating. See the *Selection Guide* tab for details.
- f. The length from the tip of the connector bulkhead to the face of the FiberPort flange, as shown in the diagram in the *Mechanism* tab.

Part Number	Description	Price	Availability
PAF-X-11-PC-A	FiberPort, FC/PC, f=11.0 mm, 350 - 700 nm, Ø1.80 mm Waist	\$502.86	Today
PAF-X-11-PC-B	FiberPort, FC/PC, f=11.0 mm, 600 - 1050 nm, Ø2.38 mm Waist	\$502.86	Today
PAF-X-11-PC-C	FiberPort, FC/PC, f=11.0 mm, 1050 - 1620 nm, Ø2.09 mm Waist	\$502.86	Today
PAF-X-11-PC-D	Customer Inspired!FiberPort, FC/PC, f=11.0 mm, 1.8 - 2.4 µm, Ø2.15 mm Waist	\$502.86	Today
PAF-X-11-PC-E	Customer Inspired!FiberPort, FC/PC, f=11.0 mm, 2 - 5 µm, Ø3.39 mm Waist	\$826.20	3-5 Days
PAF-X-15-PC-A	FiberPort, FC/PC, f=15.4 mm, 350 - 700 nm, Ø2.52 mm Waist	\$502.86	3-5 Days
PAF-X-15-PC-B	FiberPort, FC/PC, f=15.4 mm, 600 - 1050 nm, Ø3.33 mm Waist	\$502.86	3-5 Days
PAF-X-15-PC-C	FiberPort, FC/PC, f=15.4 mm, 1050 - 1620 nm, Ø2.92 mm Waist	\$502.86	Today
PAF-X-15-PC-D	FiberPort, FC/PC, f=15.4 mm, 1.8 - 2.4 µm, Ø3.02 mm Waist	\$502.86	Today
PAF-X-18-PC-A	FiberPort, FC/PC, f=18.4 mm, 350 - 700 nm, Ø3.01 mm Waist	\$546.72	Today
PAF-X-18-PC-B	FiberPort, FC/PC, f=18.4 mm, 600 - 1050 nm, Ø3.98 mm Waist	\$546.72	Today
PAF-X-18-PC-C	FiberPort, FC/PC, f=18.4 mm, 1050 - 1620 nm, Ø3.49 mm Waist	\$546.72	Today
PAF-X-18-PC-D	FiberPort, FC/PC, f=18.4 mm, 1.8 - 2.4 µm, Ø3.6 mm Waist	\$546.72	Today

Aspheric FiberPorts for FC/APC Connectors (EFL of 11 mm or Greater)

Item #	EFL	Input MFD ^{a,b}	Output 1/e ² Waist Diameter ^a	Max Waist Distance ^{a,c}	Divergence ^a	Lens Characteristics				Length L ^f
						CA ^d	NA	AR Range ^e	Material	
PAF-X-11-A	11.0 mm	3.5 µm	1.80 mm	2841 mm	0.318 mrad	4.4 mm	0.20	350 - 700 nm	H-LAK54	0.87" (22.0 mm)
PAF-X-11-B	11.0 mm	5.0 µm	2.38 mm	2630 mm	0.455 mrad	4.4 mm	0.20	650 - 1050 nm	H-LAK54	0.87" (22.0 mm)
PAF-X-11-C	11.0 mm	10.4 µm	2.09 mm	1115 mm	0.945 mrad	4.4 mm	0.20	1050 - 1620 nm	H-LAK54	0.87" (22.0 mm)
PAF-X-11-D	11.0 mm	13 µm	2.15 mm	923 mm	1.182 mrad	4.4 mm	0.20	1.8 - 2.4 µm	H-LAK54	0.87" (22.0 mm)
PAF-X-15-A	15.4 mm	3.5 µm	2.52 mm	5562 mm	0.227 mrad	5.0 mm	0.16	350 - 700 nm	ECO-550	0.87" (22.0 mm)
PAF-X-15-B	15.4 mm	5.0 µm	3.33 mm	5149 mm	0.325 mrad	5.0 mm	0.16	600 - 1050 nm	ECO-550	0.87" (22.0 mm)
PAF-X-15-C	15.4 mm	10.4 µm	2.92 mm	2179 mm	0.675 mrad	5.0 mm	0.16	1050 - 1620 nm	ECO-550	0.87" (22.0 mm)
PAF-X-15-D	15.4 mm	13 µm	3.02 mm	1802 mm	0.844 mrad	5.0 mm	0.16	1.8 - 2.4 µm	ECO-550	0.87" (22.0 mm)
PAF-X-18-A	18.4 mm	3.5 µm	3.01 mm	7936 mm	0.190 mrad	5.5 mm	0.15	350 - 700 nm	ECO-550	0.70" (17.8 mm)
PAF-X-18-B	18.4 mm	5.0 µm	3.98 mm	7347 mm	0.272 mrad	5.5 mm	0.15	600 - 1050 nm	ECO-550	0.70" (17.8 mm)
PAF-X-18-C	18.4 mm	10.4 µm	3.49 mm	3107 mm	0.565 mrad	5.5 mm	0.15	1050 - 1620 nm	ECO-550	0.70" (17.8 mm)
PAF-X-18-D	18.4 mm	13 µm	3.60 mm	2569 mm	0.707 mrad	5.5 mm	0.15	1.8 - 2.4 µm	ECO-550	0.70" (17.8 mm)

- a. These values were calculated using the following equipment: -A: 460HP at 450 nm, -B: 780HP at 850 nm, -C: SMF-28e+ at 1550 nm, -D: SM2000 at 2 µm

- b. Input Mode Field Diameter
- c. Maximum Waist Distance is defined as the maximum distance from the lens a Gaussian beam's waist can be placed.
- d. Clear Aperture
- e. Wavelength range of the antireflection coating. See the *Selection Guide* tab for details.
- f. The length from the tip of the connector bulkhead to the face of the FiberPort flange, as shown in the diagram in the *Mechanism* tab.

Part Number	Description	Price	Availability
PAF-X-11-A	FiberPort, FC/APC, f=11.0 mm, 350 - 700 nm, Ø1.80 mm Waist	\$502.86	Today
PAF-X-11-B	FiberPort, FC/APC, f=11.0 mm, 650 - 1050 nm, Ø2.38 mm Waist	\$502.86	Today
PAF-X-11-C	FiberPort, FC/APC, f=11.0 mm, 1050 - 1620 nm, Ø2.09 mm Waist	\$502.86	3-5 Days
PAF-X-11-D	Customer Inspired!FiberPort, FC/APC, f=11.0 mm, 1.8 - 2.4 µm, Ø2.15 mm Waist	\$502.86	Today
PAF-X-15-A	FiberPort, FC/APC, f=15.4 mm, 350 - 700 nm, Ø2.52 mm Waist	\$502.86	3-5 Days
PAF-X-15-B	FiberPort, FC/APC, f=15.4 mm, 600 - 1050 nm, Ø3.33 mm Waist	\$502.86	Today
PAF-X-15-C	FiberPort, FC/APC, f=15.4 mm, 1050 - 1620 nm, Ø2.92 mm Waist	\$502.86	Today
PAF-X-15-D	FiberPort, FC/APC, f=15.4 mm, 1.8 - 2.4 µm, Ø3.02 mm Waist	\$502.86	Today
PAF-X-18-A	FiberPort, FC/APC, f=18.4 mm, 350 - 700 nm, Ø3.01 mm Waist	\$546.72	Today
PAF-X-18-B	FiberPort, FC/APC, f=18.4 mm, 600 - 1050 nm, Ø3.98 mm Waist	\$546.72	3-5 Days
PAF-X-18-C	FiberPort, FC/APC, f=18.4 mm, 1050 - 1620 nm, Ø3.49 mm Waist	\$546.72	Today
PAF-X-18-D	FiberPort, FC/APC, f=18.4 mm, 1.8 - 2.4 µm, Ø3.60 mm Waist	\$546.72	Today

Aspheric FiberPorts for SMA Connectors (All Focal Lengths)

Item #	EFL	Input MFD ^{a,b}	Output 1/e ² Waist Diameter ^a	Max Waist Distance ^{a,c}	Divergence ^a	Lens Characteristics				Length L ^f
						CA ^d	NA	AR Range ^e	Material	
PAF-SMA-4-E	4.0 mm	14.47 µm	1.23 mm	169 mm	3.617 mrad	5.0 mm	0.56	2 - 5 µm	Black Diamond-2	0.85" (21.7 mm)
PAF-SMA-5-A	4.6 mm	3.5 µm	0.75 mm	499 mm	0.761 mrad	4.9 mm	0.47	350 - 700 nm	H-LAK54	0.85" (21.7 mm)
PAF-SMA-5-B	4.6 mm	5.0 µm	1.00 mm	463 mm	1.087 mrad	4.9 mm	0.47	600 - 1050 nm	H-LAK54	0.85" (21.7 mm)
PAF-SMA-5-C	4.6 mm	10.4 µm	0.87 mm	198 mm	2.261 mrad	4.9 mm	0.47	1050 - 1620 nm	H-LAK54	0.85" (21.7 mm)
PAF-SMA-5-D	4.6 mm	13 µm	0.90 mm	164 mm	2.826 mrad	4.9 mm	0.47	1.8 - 2.4 µm	H-LAK54	0.85" (21.7 mm)
PAF-SMA-7-A	7.5 mm	3.5 µm	1.23 mm	1323 mm	0.467 mrad	4.4 mm	0.29	350 - 700 nm	H-LAK54	0.85" (21.7 mm)
PAF-SMA-7-B	7.5 mm	5.0 µm	1.62 mm	1125 mm	0.667 mrad	4.4 mm	0.29	600 - 1050 nm	H-LAK54	0.85" (21.7 mm)
PAF-SMA-7-C	7.5 mm	10.4 µm	1.42 mm	521 mm	1.387 mrad	4.4 mm	0.29	1050 - 1620 nm	H-LAK54	0.85" (21.7 mm)
PAF-SMA-11-A	11.0 mm	3.5 µm	1.80 mm	2841 mm	0.318 mrad	4.4 mm	0.20	350 - 700 nm	H-LAK54	1.04" (26.3 mm)
PAF-SMA-11-B	11.0 mm	5.0 µm	2.38 mm	2630 mm	0.455 mrad	4.4 mm	0.20	600 - 1050 nm	H-LAK54	1.04" (26.3 mm)
PAF-SMA-11-C	11.0 mm	10.4 µm	2.09 mm	1115 mm	0.945 mrad	4.4 mm	0.20	1050 - 1620 nm	H-LAK54	1.04" (26.3 mm)
PAF-SMA-11-D	11.0 mm	13 µm	2.15 mm	923 mm	1.182 mrad	4.4 mm	0.20	1.8 - 2.4 µm	H-LAK54	1.04" (26.3 mm)
PAF-SMA-11-E	11.0 mm	14.47 µm	3.39 mm	1258 mm	1.315 mrad	4.0 mm	0.18	2 - 5 µm	Black Diamond-2	1.04" (26.3 mm)

- a. These values are calculated using the following equipment: -A: 460HP at 450 nm, -B: 780HP at 850 nm, -C: SMF-28e+ at 1550 nm, -D: SM2000 at 2 µm, E: ZrF₄ at 3.39 µm
- b. Input Mode Field Diameter
- c. Maximum Waist Distance is defined as the maximum distance from the lens a Gaussian beam's waist can be placed.
- d. Clear Aperture
- e. Wavelength range of the antireflection coating. See the *Selection Guide* tab for details.
- f. The length from the tip of the connector bulkhead to the face of the FiberPort flange, as shown in the diagram in the *Mechanism* tab.

Part Number	Description	Price	Availability
PAF-SMA-4-E	Customer Inspired!FiberPort, SMA, f=4.0 mm, 2 - 5 µm, Ø1.23 mm Waist	\$776.22	Today
PAF-SMA-5-A	FiberPort, SMA, f=4.6 mm, 350 - 700 nm, Ø0.75 mm Waist	\$393.72	Today

PAF-SMA-5-B	FiberPort, SMA, f=4.6 mm, 600 - 1050 nm, Ø1.00 mm Waist	\$393.72	Today
PAF-SMA-5-C	FiberPort, SMA, f=4.6 mm, 1050 - 1620 nm, Ø0.87 mm Waist	\$393.72	Today
PAF-SMA-5-D	Customer Inspired!FiberPort, SMA, f=4.6 mm, 1.8 - 2.4 µm, Ø0.90 mm Waist	\$393.72	Today
PAF-SMA-7-A	FiberPort, SMA, f=7.5 mm, 350 - 700 nm, Ø1.23 mm Waist	\$393.72	Today
PAF-SMA-7-B	FiberPort, SMA, f=7.5 mm, 600 - 1050 nm, Ø1.62 mm Waist	\$393.72	Today
PAF-SMA-7-C	FiberPort, SMA, f=7.5 mm, 1050 - 1620 nm, Ø1.42mm Waist	\$393.72	Today
PAF-SMA-11-A	FiberPort, SMA, f=11.0 mm, 350 - 700 nm, Ø1.80 mm Waist	\$410.04	Today
PAF-SMA-11-B	FiberPort, SMA, f=11.0 mm, 600 - 1050 nm, Ø2.38 mm Waist	\$410.04	Today
PAF-SMA-11-C	FiberPort, SMA, f=11.0 mm, 1050 - 1620 nm, Ø2.09 mm Waist	\$410.04	Today
PAF-SMA-11-D	Customer Inspired!FiberPort, SMA, f=11.0 mm, 1.8 - 2.4 µm, Ø2.15 mm Waist	\$410.04	Today
PAF-SMA-11-E	Customer Inspired!FiberPort, SMA, f=11.0 mm, 2 - 5 µm, Ø3.39 mm Waist	\$771.12	Today