

56 Sparta Avenue • Newton, New Jersey 07860
 (973) 300-3000 Sales • (973) 300-3600 Fax
 www.thorlabs.com

THORLABS

8051M-GE-TE - JUN 11, 2021

Item # 8051M-GE-TE was discontinued on JUN 11, 2021. For informational purposes, this is a copy of the website content at that time and is valid only for the stated product.

8 MEGAPIXEL CCD SCIENTIFIC CAMERAS FOR MICROSCOPY

- ▶ 8 Megapixel Monochrome and Color CCD Cameras
- ▶ Scientific-Grade Cameras with Low Read Noise
- ▶ Up to 17.1 Frames per Second for the Full Sensor
- ▶ Support for LabVIEW, MATLAB, μ Manager, and MetaMorph



8051M-USB
Non-Cooled



S805MU1
Camera with the Sensor
Face Plate Removed and a



8051C-GE-TE
Hermetically Sealed
Two-Stage Cooled Color Camera



Application Idea
8051M-GE Scientific CCD Camera Mounted
®

OVERVIEW

Features

- 4/3" Format, 3296 x 2472 Monochrome or Color CCD Sensor (On Semi KAI-08051M or KAI-08051-FBA) for Large Field of View
- Available in Non-Cooled Standard Packaging or Hermetically Sealed TE-Cooled Packaging
- Configuration Offered with the Sensor Face Plate Removed to Reduce Fringing in Coherent Light Applications, such as Beam Profiling
- Low Read Noise Improves the Threshold of Detectability Under Low Light Conditions
- Software-Selectable 20 MHz or 40 MHz Readout: Maximize Frame Rate (40 MHz) or Minimize Noise (20 MHz)
- Asynchronous Reset, Triggered, and Bulb Exposure Modes (See *Triggering* Tab for Details)
- ThorCam GUI with 32- and 64-Bit Windows® 7 or 10 Support
- SDK and Programming Interface Support:
 - C, C++, C#, Python, and Visual Basic .NET APIs
 - LabVIEW, MATLAB, µManager, and MetaMorph Third-Party Software
- 1/4"-20 Tapped Holes for Post Mounting

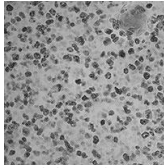

Click to Enlarge
A brightfield microscopy image acquired with one of our 8 megapixel cameras showing ki-67 labeled tonsil cells. Ki-67 is an antigen which appears only in the nuclei of cells undergoing division, and therefore is an excellent marker to indicate the growth fraction of a cell population. For more image samples, please see the Applications tab.

Scientific Camera Selection Guide	
CMOS & sCMOS Sensors	Zelux™ CMOS (Smallest Profile)
	Kiralux® CMOS
	Kiralux Polarization-Sensitive CMOS
CCD Sensors	Quantalux® sCMOS (<1 e- Read Noise)
	1.4 MP CCD
	4 MP CCD
	8 MP CCD
VGA Resolution CCD (200 Frames Per Second)	



Jason Mills
General Manager,
Thorlabs Scientific Imaging

Feedback?
Questions?
Need a Quote?

Contact Me

Thorlabs' 8 Megapixel CCD Cameras (US Patent 9,380,241 B2), which offer up to 17.1 frames per second at 40 MHz quad-tap readout of the full sensor, are specifically designed for demanding scientific imaging applications such as microscopy or those requiring coherent light. These cameras are ideal for brightfield microscopy, inspection, and other techniques that would benefit from a low-noise, large field of view imager.

With the exception of the S805MUx models, each camera comes with a user-removable IR filter; for complete details on the transmission please see the *Specs* tab. If the filter is removed, it can be replaced with a user-supplied Ø1" (Ø25 mm) filter or another optic up to 4 mm thick; please see the camera manual, found under the red Docs icons (📄) below, for details. Our S805MU1 and S805MU2 cameras are identical to the 8051M-USB camera, except that the sensor face plate is removed and the IR filter is replaced with a wedged window. These models are ideal for applications that are sensitive to interference patterns caused by reflections from the sensor face plate.

USB 3.0 or Gigabit Ethernet Industry-Standard Interfaces

Thorlabs' 8 megapixel cameras have either a USB 3.0 or Gigabit Ethernet (GigE) interface. GigE is ideal for situations where the camera must be far from the PC or there are multiple cameras that need to be controlled by the same PC. The GigE cameras are provided with a GigE frame grabber card and cables. Since USB 3.0 is supported by most computers, the USB cameras do not come with a card; however, one is available separately. A power supply and software are supplied with all cameras. More information on what's included is on the *Shipping List* tab. Your computer must have a free PCI Express slot to install the GigE interface. For more information on the three interface options and recommended computer specifications, please see the *Interface* tab.

Our cameras have triggering options that enable custom timing and system control; for more details, please see the *Triggering* tab. External triggering requires a connection to the auxiliary port of the camera. Accessory cables and boards to "break out" the individual signals are available below.



Specs

Common Specifications ^a	
Sensor Type	ON Semiconductor KAI-08051
Number of Active Pixels	3296 x 2472 (Horizontal x Vertical)
Imaging Area	18.13 mm x 13.60 mm (Horizontal x Vertical)
Pixel Size	5.5 μm x 5.5 μm
Optical Format	4/3" Format (22 mm Diagonal)
Peak Quantum Efficiency	Monochrome: 51% at 460 nm Color: See Graph to the Right
Exposure Time	0 to 1000 s in 1 ms Increments ^b
CCD Pixel Clock Speed	20 or 40 MHz
ADC Gain ^c	0 to 1023 Steps (0.036 dB/Step)
Optical Black Clamp	0 to 1023 Steps (0.036 dB/Step)
Vertical Hardware Binning ^e	Continuous Integer Values from 1 to 10
Horizontal Software Binning ^e	Continuous Integer Values from 1 to 10
Region of Interest	1 x 1 Pixel to 3296 x 2472 Pixels Rectangular
Read Noise ^f	<10 e ⁻ at 20 MHz

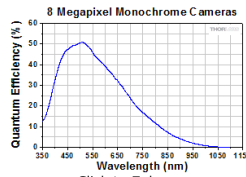

This curve shows the quantum efficiency for the monochrome camera sensor.

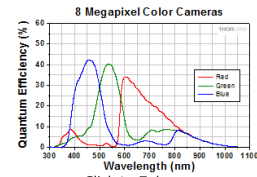

This curve shows the quantum efficiency for the color camera sensor's red, green, and blue pixels.

Sample Frame Rates at 1 ms Exposure Time

CCD Size and Binning ^a	Single Tap		Dual Tap		Quad Tap ^b	
	20 MHz	40 MHz	20 MHz	40 MHz	20 MHz	40 MHz
Full Sensor (3296 x 2472)	2.3 fps	4.5 fps	4.4 fps	8.5 fps	8.8 fps	17.1 fps
Full Sensor, Bin by 2 (1648 x 1048)	4.4 fps	8.5 fps	8.3 fps	15.7 fps	16.6 fps	31.2 fps
Full Sensor, Bin by 10 (329 x 247)	17.0 fps	29.9 fps	29.0 fps	47.1 fps	56.8 fps	92.3 fps

Camera Frame Rate is impacted by the Vertical Hardware Binning parameter. For color cameras, when the Image Type setting in ThorCam is anything other than "Unprocessed" only 1 x 1 binning is available. When set to Unprocessed, the camera can bin up to 24 x 24, but the image produced will be monochrome. Quad-tap operation is only available with USB 3.0 versions; GigE only supports Single- and Dual-tap operation.

- The specified performance is valid when using a computer with the recommended specifications listed on the *Interface* tab.
- Exposure time varies with operating mode; exposure times shorter than 1 ms may be possible when using an external trigger.
- ADC = Analog-to-Digital Converter
- ADU = Analog-to-Digital Unit
- Camera Frame Rate is impacted by the Vertical Hardware Binning parameter. For color cameras, when the Image Type setting in ThorCam is anything other than "Unprocessed" only 1 x 1 binning is available. When set to Unprocessed, the camera can bin up to 24 x 24, but the image produced will be monochrome.
- If your application is read-noise limited, we recommend using the lower CCD pixel clock speed of 20 MHz. For more information about read noise, and for examples of how to estimate the limiting factor of total camera noise, please see the *Camera Noise* Tab.

Monochrome Item # ^a	S805MU1	S805MU2	8051M-USB	8051M-USB-TE	8051M-GE	8051M-GE-TE
Color Item # ^a	N/A	N/A	8051C-USB	8051C-USB-TE	8051C-GE	8051C-GE-TE
Number of Taps (Software Selectable)	Single, Dual, Quad				Single, Dual	
Digital Output	14 Bit				Single Tap: 14 Bit Dual-Tap: 12 Bit	
Cooling	No			Sensor Cools to -10 °C at 20 °C Ambient Temperature	No	Sensor Cools to -10 °C at 20 °C Ambient Temperature
Host PC Interface ^a	USB 3.0				Gigabit Ethernet	
Lens Mount	1.375"-32 Threading		C-Mount (1.000"-32)			
Built in Optics (Click for Graphs)	Wedged Window (400- 700 nm) ^b	Wedged Window (700 - 1100 nm) ^b	IR Blocking Filter ^c			

- For more information on these interface options, please see the *Interface* tab.
- Click here for wedged window reflectance raw data.
- Click here for IR blocking filter transmission raw data.

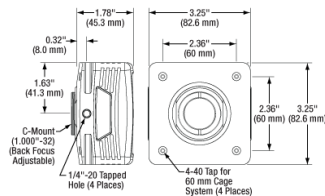

Click to Enlarge
Non-Cooled Standard Packaging

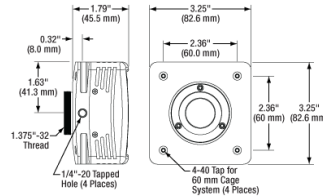

Click to Enlarge
Packaging for Cameras with the Sensor Face Plate Removed

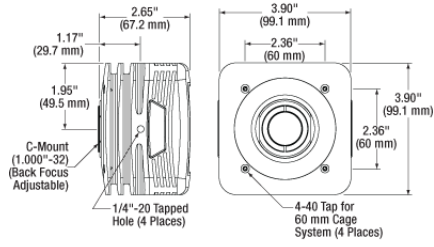



Click to Enlarge
Hermetically Sealed Cooled Packaging

Apps

Thorlabs' Scientific-Grade CCD Cameras are ideal for a variety of applications. The photo gallery below contains images acquired with our 1.4 megapixel, 4 megapixel, 8 megapixel, and fast frame rate cameras.

To download some of these images as high-resolution, 16-bit TIFF files, please click here. It may be necessary to use an alternative image viewer to view the 16-bit files. We recommend ImageJ, which is a free download.

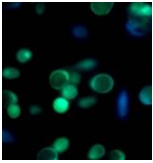
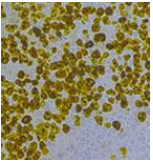
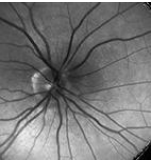
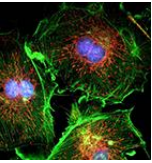
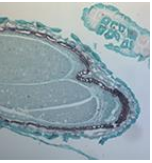
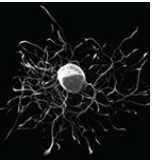
Thorlabs' Scientific Camera Applications (Click Images for Details)

						
Intracellular Dynamics	Brightfield Microscopy	Ophthalmology (NIR)	Fluorescence Microscopy	Multispectral Imaging	Neuroscience	Fast Frame Rate
Thorlabs' Scientific Camera Recommended for Above Application						
1.4 Megapixel Fast Frame Rate	4 Megapixel 8 Megapixel	1.4 Megapixel	4 Megapixel 1.4 Megapixel	4 Megapixel 1.4 Megapixel	1.4 Megapixel	1.4 4 Fas

Multispectral Imaging

The video to the right is an example of a multispectral image acquisition using a liquid crystal tunable filter (LCTF) in front of a monochrome camera. With a sample slide exposed to broadband light, the LCTF passes narrow bands of light that are transmitted from the sample. The monochromatic images are captured using a monochrome scientific camera, resulting in a datacube – a stack of spectrally separated two-dimensional images which can be used for quantitative analysis, such as finding ratios or thresholds and spectral unmixing.

In the example shown, a mature *capsella bursa-pastoris* embryo, also known as Shepherd's-Purse, is rapidly scanned across the 420 nm - 730 nm wavelength range using Thorlabs' KURIOS-WB1 Liquid Crystal Tunable Filter. The images are captured using our 1501M-GE Scientific Camera, which is connected, with the liquid crystal filter, to a Cerna® Series Microscope. The overall system magnification is 10X. The final stacked/recovered image is shown below.

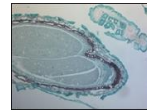

Click to Enlarge
Final Stacked/Recovered
Image

Thrombosis Studies

Thrombosis is the formation of a blood clot within a blood vessel that will impede the flow of blood in the circulatory system. The videos below are from experimental studies on the large-vessel thrombosis in Mice performed by Dr. Brian Cooley at the Medical College of Wisconsin. Three lasers (532 nm, 594 nm, and 650 nm) were expanded and then focused on a microsurgical field of an exposed surgical site in an anesthenized mouse. A custom 1.4 Megapixel Camera with integrated filter wheel were attached to a Leica Microscope to capture the low-light fluorescence emitted from the surgical site. See the videos below with their associated descriptions for further information.

Arterial Thrombosis

In the video above, a gentle 30-second electrolytic injury is generated on the surface of a carotid artery in an atherogenic mouse (ApoE-null on a high-fat, "Western" diet), using a 100-micron-diameter iron wire (creating a free-radical injury). The site (arrowhead) and the vessel are imaged by time-lapse fluorescence-capture, low-light camera over 60 minutes (timer is shown in upper left corner – hours:minutes:seconds). Platelets were labeled with a green fluorophore (rhodamine 6G) and anti-fibrin antibodies with a red fluorophore (Alexa-647) and injected prior to electrolytic injury to identify the development of platelets and fibrin in the developing thrombus. Flow is from left to right; the artery is approximately 500 microns in diameter (bar at lower right, 350 microns).

Venous Thrombosis

In the video above, a gentle 30-second electrolytic injury is generated on the surface of a murine femoral vein, using a 100-micron-diameter iron wire (creating a free-radical injury). The site (arrowhead) and the vessel are imaged by time-lapse fluorescence-capture, low-light camera over 60 minutes (timer is shown in upper left corner – hours:minutes:seconds). Platelets were labeled with a green fluorophore (rhodamine 6G) and anti-fibrin antibodies with a red fluorophore (Alexa-647) and injected prior to electrolytic injury to identify the development of platelets and fibrin in the developing thrombus. Flow is from left to right; the vein is approximately 500 microns in diameter (bar at lower right, 350 microns).

Reference: Cooley BC. In vivo fluorescence imaging of large-vessel thrombosis in mice. *Arterioscler Thromb Vasc Biol* 31, 1351-1356, 2011. All animal studies were done under protocols approved by the Medical College of Wisconsin Institutional Animal Care and Use Committee.

Pin Diagrams

Camera Back Panel Connector Locations

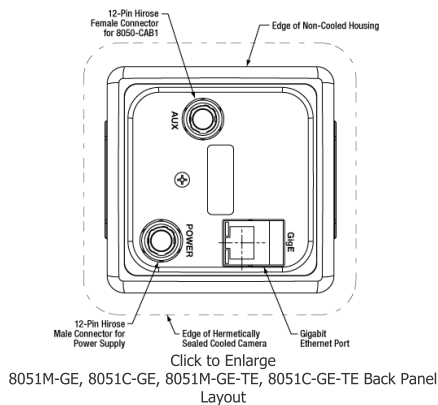
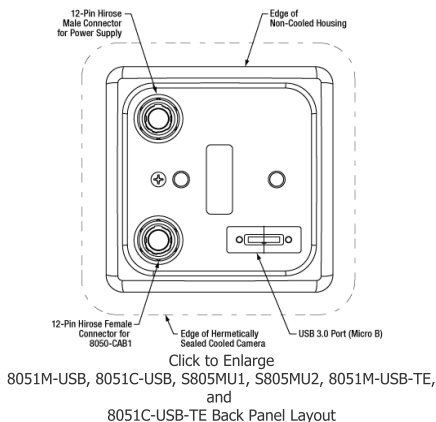

TSI-IOBOB and TSI-IOBOB2 Break-Out Board Connector Locations

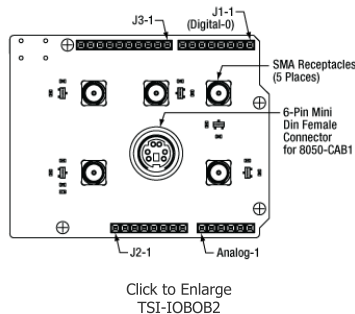
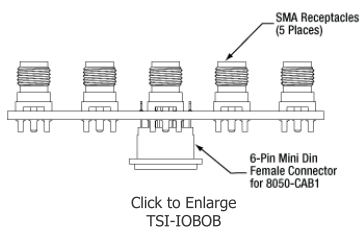

Auxiliary Connector

The cameras and the break-out boards both feature female connectors; the 8 megapixel cameras have a 12 pin Hirose connector, while the break out boards have a 6-pin Mini-DIN connector.

TSI-IOBOB and TSI-IOBOB2 Connector	8050-CAB1 Connectors	Camera Auxiliary (AUX) Port
<p>Female 6-Pin Mini Din Female Connector</p>	<p>Male 6-Pin Mini Din Male Connector (TSI-IOBOB end of Cable)</p>	<p>Male 12-Pin Hirose Connector (Camera end of Cable)</p>
		<p>Female 12-Pin Hirose Connector (Auxiliary Port on Camera)</p>

The 8050-CAB1 cable features male connectors on both ends: a 12-pin connector for connecting to the camera and a 6-pin Mini-DIN connector for the break-out boards. Pins 1, 2, 3, 5, and 6 are each connected to the center pin of an SMA connector on the break-out boards, while pin 4 (ground) is connected to each SMA connector housing. To access one of the I/O functions not available with the 8050-CAB1, the user must fabricate a cable using shielded cabling in order for the camera to adhere to CE and FCC compliance; additional details are provided in the camera manual.

Camera AUX Pin #	TSI-IOBOB and TSI-IOBOB2 Pin #	Signal	Description
1	-	Reserved	Reserved for future use
2	-	Reserved	Reserved for future use
3	-	Reserved	Reserved for future use
4	6	STROBE_OUT (Output)	A TTL output that is high during the actual sensor exposure time when in continuous, overlapped exposure mode. It is typically used to synchronize an external flash lamp or other device with the camera.
5	3	TRIGGER_IN (Input)	A TTL input used to trigger exposures on the transition from the high to low state.
6	1	LVAL (Output)	Refers to "Line Valid." It is an active-high TTL signal and is asserted during the valid period on each line. It returns low during the inter-line period between each line and during the inter-frame period between each frame.
7	2	TRIGGER_OUT (Output)	A 6 μs positive pulse asserted when using the various external trigger input options; TRIGGER_IN or LVDS_TRIGGER_IN. The signal is brought out of the camera as TRIGGER_OUT at the High-to-Low transition to allow triggering of other devices.
8	-	LVDS_TRIGGER_IN_N (Input, Differential Pair with Pin 9)	A LVDS (low-voltage differential signal) input used to trigger exposures on the transition from the high state to low state. The suffix "N" identifies this as the negative input of the LVDS signal.
9	-	LVDS_TRIGGER_IN_P (Input, Differential Pair with Pin 9)	A LVDS (low-voltage differential signal) input used to trigger exposures on the transition from the high state to low state. The suffix "P" identifies this as the positive input of the LVDS signal.
10	4	GND	The electrical ground for the camera signals

Camera AUX Pin #	TSI- IOBOB and TSI- IOBOB2 Pin #	Signal	Description
11	-	Reserved	Reserved for future use
12	5	FVAL_OUT (Output)	Refers to "Frame Valid." It is a TTL output that is high during active readout lines and returns low between frames.

Software

ThorCam™

ThorCam is a powerful image acquisition software package that is designed for use with our cameras on 32- and 64-bit Windows® 7 or 10 systems. This intuitive, easy-to-use graphical interface provides camera control as well as the ability to acquire and play back images. Single image capture and image sequences are supported. Please refer to the screenshots below for an overview of the software's basic functionality.

Application programming interfaces (APIs) and a software development kit (SDK) are included for the development of custom applications by OEMs and developers. The SDK provides easy integration with a wide variety of programming languages, such as C, C++, C#, Python, and Visual Basic .NET. Support for third-party software packages, such as LabVIEW, MATLAB, and µManager* is available. We also offer example Arduino code for integration with our TSI-IOBOB2 Interconnect Break-Out Board.

*µManager control of Zelux and 1.3 MP Kiralux cameras is not currently supported. When controlling the Kiralux Polarization-Sensitive Camera using µManager, only intensity images can be taken; the ThorCam software is required to produce images with polarization information.

Recommended System Requirements ^a	
Operating System	Windows® 7 or 10 (64 Bit)
Processor (CPU) ^b	≥3.0 GHz Intel Core (i5 or Higher)
Memory (RAM)	≥8 GB
Hard Drive ^c	≥500 GB (SATA) Solid State Drive (SSD)
Graphics Card ^d	Dedicated Adapter with ≥256 MB RAM
Motherboard	USB 3.0 (-USB) Cameras: Integrated Intel USB 3.0 Controller or One Unused PCIe x1 Slot (for Item # USB3-PCIE) GigE (-GE) Cameras: One Unused PCIe x1 Slot
Connectivity	USB or Internet Connectivity for Driver Installation

- See the Performance Considerations section below for recommendations to minimize dropped frames for demanding applications.
- Intel Core i3 processors and mobile versions of Intel processors may not satisfy the requirements.
- We recommend a solid state drive (SSD) for reliable streaming to disk during image sequence storage.
- On-board/integrated graphics solutions present on Intel Core i5 and i7 processors are also acceptable.

Software

Version 3.5.1

Click the button below to visit the ThorCam software page.



Example Arduino Code for TSI-IOBOB2 Board

Click the button below to visit the download page for the sample Arduino programs for the TSI-IOBOB2 Shield for Arduino. Three sample programs are offered:

- Trigger the Camera at a Rate of 1 Hz
- Trigger the Camera at the Fastest Possible Rate
- Use the Direct AVR Port Mappings from the Arduino to Monitor Camera Acquisition



Click the Highlighted Regions to Explore ThorCam Features

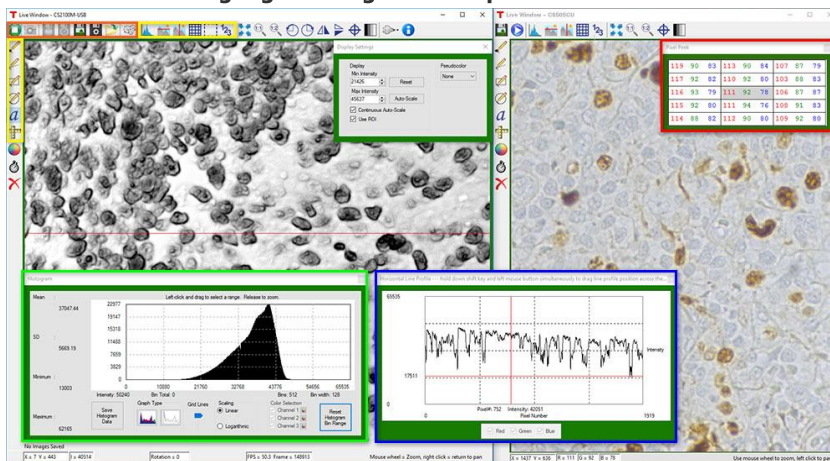

Camera Control and Image Acquisition

Camera Control and Image Acquisition functions are carried out through the icons along the top of the window, highlighted in orange in the image above. Camera parameters may be set in the popup window that appears upon clicking on the Tools icon. The Snapshot button allows a single image to be acquired using the current camera settings.

The Start and Stop capture buttons begin image capture according to the camera settings, including triggered imaging.

Timed Series and Review of Image Series

The Timed Series control, shown in Figure 1, allows time-lapse images to be recorded. Simply set the total number of images and the time delay in between captures. The output will be saved in a multi-page TIFF file in order to preserve the high-precision, unaltered image data. Controls within ThorCam allow the user to play the sequence of images or step through them frame by frame.

Measurement and Annotation

As shown in the yellow highlighted regions in the image above, ThorCam has a number of built-in annotation and measurement functions to help analyze images after they have been acquired. Lines, rectangles, circles, and freehand shapes can be drawn on the image. Text can be entered to annotate marked locations. A measurement mode allows the user to determine the distance between points of interest.

The features in the red, green, and blue highlighted regions of the image above can be used to display information about both live and captured images.

ThorCam also features a tally counter that allows the user to mark points of interest in the image and tally the number of points marked (see Figure 2). A crosshair target that is locked to the center of the image can be enabled to provide a point of reference.

Third-Party Applications and Support

ThorCam is bundled with support for third-party software packages such as LabVIEW, MATLAB, and .NET. Both 32- and 64-bit versions of LabVIEW and MATLAB are supported. A full-featured and well-documented API, included with our cameras, makes it convenient to develop fully customized applications in an efficient manner, while also providing the ability to migrate through our product line without having to rewrite an application.



Click to Enlarge
Figure 1: A timed series of 10 images taken at 1 second intervals is saved as a multipage TIFF.

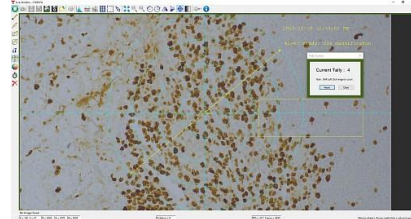

Click to Enlarge
Figure 2: A screenshot of the ThorCam software showing some of the analysis and annotation features. The Tally function was used to mark four locations in the image. A blue crosshair target is enabled and locked to the center of the image to provide a point of reference.

Performance Considerations

Please note that system performance limitations can lead to "dropped frames" when image sequences are saved to the disk. The ability of the host system to keep up with the camera's output data stream is dependent on multiple aspects of the host system. Note that the use of a USB hub may impact performance. A dedicated connection to the PC is preferred. USB 2.0 connections are not supported.

First, it is important to distinguish between the frame rate of the camera and the ability of the host computer to keep up with the task of displaying images or streaming to the disk without dropping frames. The frame rate of the camera is a function of exposure and readout (e.g. clock, ROI) parameters. Based on the acquisition parameters chosen by the user, the camera timing emulates a digital counter that will generate a certain number of frames per second. When displaying images, this data is handled by the graphics system of the computer; when saving images and movies, this data is streamed to disk. If the hard drive is not fast enough, this will result in dropped frames.

One solution to this problem is to ensure that a solid state drive (SSD) is used. This usually resolves the issue if the other specifications of the PC are sufficient. Note that the write speed of the SSD must be sufficient to handle the data throughput.

Larger format images at higher frame rates sometimes require additional speed. In these cases users can consider implementing a RAID0 configuration using multiple SSDs or setting up a RAM drive. While the latter option limits the storage space to the RAM on the PC, this is the fastest option available. ImDisk is one example of a free RAM disk software package. It is important to note that RAM drives use volatile memory. Hence it is critical to ensure that the data is moved from the RAM drive to a physical hard drive before restarting or shutting down the computer to avoid data loss.

SHIPPING LIST

S805MU1 and S805MU2 Contents Example

Click to Enlarge
Item # Shown: S805MU1

In Addition to the Camera, Each S805MU Item Includes the Following:

- USB 3.0 Cable (Micro B to A)
- Power Supply, with Region-Specific Power Cord
- CD with ThorCam Software
- Quick-Start Guide and Manual Download Information Card

USB 3.0 Contents Example

Click to Enlarge
Item # Shown: 8051M-USB

In Addition to the Camera, Each USB3.0 Item Includes the Following:

- USB 3.0 Cable (Micro B to A)
- Power Supply, with Region-Specific Power Cord
- Wrench to Loosen Optical Assembly
- Lens Mount Dust Cap (Also Functions as IR Filter Removal Tool)
- CD with ThorCam Software
- Quick-Start Guide and Manual Download Information Card

Gigabit Ethernet Contents Example

Click to Enlarge
Item # shown: 8051M-GE

In Addition to the Camera, Each GigE Item Includes the Following:

- Gigabit Ethernet PCI Express Card
- Gigabit Ethernet Cable
- Power Supply, with Region-Specific Power Cord
- Wrench to Loosen Optical Assembly
- Lens Mount Dust Cap (Also Functions as IR Filter Removal Tool)
- CD with ThorCam Software
- Quick-Start Guide and Manual Download Information Card

Camera Noise

Camera Noise and Temperature

Overview

When purchasing a camera, an important consideration is whether or not the application will require a cooled sensor. Generally, most applications have high signal levels and do not require cooling. However, for certain situations, generally under low light levels where long exposures are necessary, cooling will provide a benefit. In the tutorial below, we derive the following "rule of thumb": for exposures less than 1 second, a standard camera is generally sufficient; for exposures greater than 1 second, cooling could be beneficial; for exposures greater than 5 seconds, cooling is generally recommended; and for exposures above 10 seconds, cooling is usually required. If you have questions about which domain your application will fall, you might consider estimating the signal levels and noise sources by following the steps detailed in the tutorial below, where we present sample calculations using the specifications for our 1.4 megapixel monochrome cameras. Alternatively you can contact us, and one of our scientific camera specialists will help you decide which camera is right for you.

Sources of Noise

Noise in a camera image is the aggregate spatial and temporal variation in the measured signal, assuming constant, uniform illumination. There are several components of noise:

- **Dark Shot Noise (σ_D):** Dark current is a current that flows even when no photons are incident on the camera. It is a thermal phenomenon resulting from electrons spontaneously generated within the silicon chip (valence electrons are thermally excited into the conduction band). The variation in the amount of dark electrons collected during the exposure is the dark shot noise. It is independent of the signal level but is dependent on the temperature of the sensor as shown in Table 1.
- **Read Noise (σ_R):** This is the noise generated in producing the electronic signal. This results from the sensor design but can also be impacted by the design of the camera electronics. It is independent of signal level and temperature of the sensor, and is larger for faster CCD pixel clock rates.
- **Photon Shot Noise (σ_S):** This is the statistical noise associated with the arrival of photons at the pixel. Since photon measurement obeys Poisson statistics, the photon shot noise is dependent on the signal level measured. It is independent of sensor temperature.
- **Fixed Pattern Noise (σ_F):** This is caused by spatial non-uniformities of the pixels and is independent of signal level and temperature of the sensor. Note that fixed pattern noise will be ignored in the discussion below; this is a valid assumption for the CCD cameras sold here but may need to be included for other non-scientific-grade sensors.

Total Effective Noise

The total effective noise per pixel is the quadrature sum of each of the noise sources listed above:

$$\sigma_{eff} = \sqrt{\sigma_D^2 + \sigma_R^2 + \sigma_S^2} \quad (1)$$

Here, σ_D is the dark shot noise, σ_R is the read noise (for sample calculations, we will use our 1.4 megapixel monochrome cameras, which use the ICX285AL sensor. Typically the read noise is less than 10 e- for scientific-grade cameras using the ICX285AL CCD; we will assume a value of 10 e- in this tutorial), and σ_S is the photon shot noise. If $\sigma_S \gg \sigma_D$ and $\sigma_S \gg \sigma_R$, then σ_{eff} is approximately given by the following:

$$\sigma_{eff} = \sqrt{\sigma_S^2} = \sigma_S \quad (2)$$

Again, fixed pattern noise is ignored, which is a good approximation for scientific-grade CCDs but may need to be considered for non-scientific-grade sensors.

Dark Shot Noise and Sensor Temperature

As mentioned above, the dark current is a thermal effect and can therefore be reduced by cooling the sensor. Table 1 lists typical dark current values for the Sony ICX285AL CCD sensor used in our 1.4 megapixel monochrome cameras. As the dark current results from spontaneously generated electrons, the dark current is measured by simply "counting" these electrons. Since counting electrons obeys Poisson statistics, the noise associated with the dark current I_D is proportional to the square root of the number of dark electrons that accumulate during the exposure. For a given exposure, the dark shot noise, σ_D , is therefore the square root of the I_D value from Table 1 (for a given sensor temperature) multiplied by the exposure time t in seconds:

$$\sigma_D = \sqrt{I_D t} \quad (3)$$

Since the dark current decreases with decreasing temperature, the associated noise can be decreased by cooling the camera. For example, assuming an exposure of 5 seconds, the dark shot noise levels for the three sensor temperatures listed in the table are

$$\begin{aligned} \sigma_D(25\text{ }^\circ\text{C}) &= \sqrt{5 * 5} = 5\text{ e-} \\ \sigma_D(0\text{ }^\circ\text{C}) &= \sqrt{5 * 1} = 2.2\text{ e-} \\ \sigma_D(-20\text{ }^\circ\text{C}) &= \sqrt{5 * 0.1} = 0.7\text{ e-} \end{aligned} \quad (4)$$

Figure 1, which is a plot of the dark shot noise as a function of exposure for the three temperatures listed in Table 1, illustrates how the dark shot noise increases with increasing exposure. Figure 1 also includes a plot of the upper limit of the read noise.

Temperature	Dark Current (I_D)
-20 °C	0.1 e ⁻ /(s*pixel)
0 °C	1 e ⁻ /(s*pixel)
25 °C	5 e ⁻ /(s*pixel)

Table 1: Nominal dark current values at several temperatures for the Sony ICX285AL CCD sensor used in our 1.4 megapixel CCD cameras.

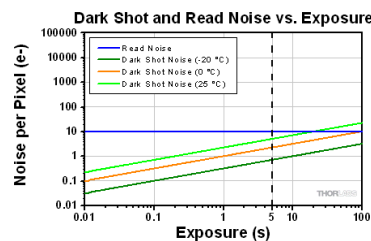

Figure 1: Plot of dark shot noise and read noise as a function of exposure for three sensor temperatures for our 1.4 megapixel cameras. This plot uses logarithmic scales for both axes. The dotted vertical line at 5 s indicates the values calculated as the example in the text.

If the photon shot noise is significantly larger than the dark shot noise, then cooling provides a negligible benefit in terms of the noise, and our standard package cameras will work well.

Photon Shot Noise

If S is the number of "signal" electrons generated when a photon flux of N photons/second is incident on each pixel of a sensor with a quantum efficiency QE and an exposure duration of t seconds, then

$$S = (QE)Nt \quad (5)$$

From S , the photon shot noise, σ_S , is given by:

$$\sigma_S = \sqrt{(QE)Nt} \quad (6)$$

Example Calculations (Using our 1.4 Megapixel Cameras)

If we assume that there is a sufficiently high photon flux and quantum efficiency to allow for a signal S of 10,000 e- to accumulate in a pixel with an exposure of 5 seconds, then the estimated shot noise, σ_S , would be the square root of 10,000, or 100 e-. The read noise is 10 e- (independent of exposure time). For an exposure of 5 seconds and sensor temperatures of 25, 0, and -25 °C, the dark shot noise is given in equation (4). The effective noise is:

$$\sigma_{eff} = \sqrt{\sigma_D^2 + \sigma_R^2 + \sigma_S^2}$$

$$\sigma_{eff}(25 \text{ }^\circ\text{C}) = \sqrt{5^2 + 10^2 + 100^2} = 100.6 \text{ e-} \quad (7)$$

$$\sigma_{eff}(0 \text{ }^\circ\text{C}) = \sqrt{2.2^2 + 10^2 + 100^2} = 100.5 \text{ e-}$$

$$\sigma_{eff}(-20 \text{ }^\circ\text{C}) = \sqrt{0.7^2 + 10^2 + 100^2} = 100.5 \text{ e-}$$

The signal-to-noise ratio (SNR) is a useful figure of merit for image quality and is estimated as:

$$SNR = \frac{S}{\sigma_{eff}} \quad (8)$$

From Equation 7, the SNR values for the three sensor temperatures are:

$$SNR(25 \text{ }^\circ\text{C}) = \frac{10000}{100.6} = 99.4 \quad (9)$$

$$SNR(0 \text{ }^\circ\text{C}, -20 \text{ }^\circ\text{C}) = \frac{10000}{100.5} = 99.5$$

As the example shows, there is a negligible benefit to using a cooled camera compared to a non-cooled camera operating at room temperature, and the photon shot noise is the dominant noise source in this example. In this case our standard package cameras should therefore work quite well.

However, if the light levels were lower such that a 100 second exposure was required to achieve 900 e- per pixel, then the shot noise would be 30 e-. The estimated dark shot noise would be 22.4 e- at 25 °C, while at -20 °C the dark shot noise would be 3.2 e-. The total effective noise would be

$$\sigma_{eff}(25 \text{ }^\circ\text{C}) = \sqrt{22.4^2 + 10^2 + 30^2} = 38.7 \text{ e-} \quad (10)$$

$$\sigma_{eff}(-20 \text{ }^\circ\text{C}) = \sqrt{3.2^2 + 10^2 + 30^2} = 31.8 \text{ e-}$$

From Equation 8, the SNR values are

(11)

$$SNR(25\text{ }^{\circ}\text{C}) = \frac{900}{38.7} = 23.3$$

$$SNR(-20\text{ }^{\circ}\text{C}) = \frac{900}{31.8} = 28.3$$

In this example, the dark shot noise is a more significant contributor to the total noise for the 25 °C sensor than for the -25 °C sensor. Depending on the application's noise budget, a cooled camera may be beneficial.

Exposure	Camera Recommendation
<1 s	Standard Non-Cooled Camera Generally Sufficient
1 s to 5 s	Cooled Camera Could Be Helpful
5 s to 10 s	Cooled Camera Recommended
>10 s	Cooled Camera Usually Required

Figure 2 shows plots of the different noise components, including dark shot noise at three sensor temperatures, as a function of exposure time for three photon fluxes. The plots show that dark shot noise is not a significant contributor to total noise except for low signal (and consequently long exposure) situations. While the photon flux levels used for the calculations are given in the figure, it is not necessary to know the exact photon flux level for your application. Figure 2 suggests a general metric based on exposure time that can be used to determine whether a cooled camera is required if the exposure time can be estimated, and these results are summarized in Table 2. If you find that your dominant source of noise is due to the read noise, then we recommend running the camera at a lower CCD pixel clock rate of 20 MHz, since that will offer a lower read noise.

Table 2: From the results shown in Figure 1, these are the general "rule of thumb" recommendations related to colling considerations based on the exposure requirements of an application. Please keep in mind that some applications are more sensitive to noise than others.

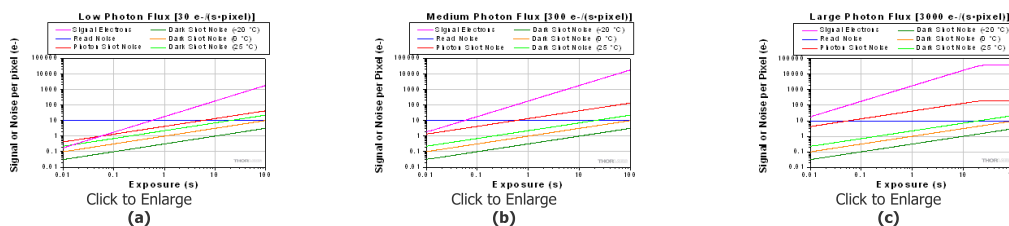

Figure 2: Noise from all sources as a function of exposure for three different photon fluxes: (a) low, (b) medium, and (c) high. In (c) the signal and photon shot noise saturate above approximately 20 seconds because the pixel becomes saturated at the corresponding incident photon levels. A quantum efficiency of 60% was used for the calculations. Note that these plots use logarithmic scales for both axes.

Other Considerations

Thermoelectric cooling should also be considered for long exposures even where the dark shot noise is not a significant contributor to total noise because cooling also helps to reduce the effects of hot pixels. Hot pixels cause a "star field" pattern that appears under long exposures. Figure 3 shows an example of this star field pattern for images taken using cameras with and without TEC cooling with an exposure of 10 seconds.

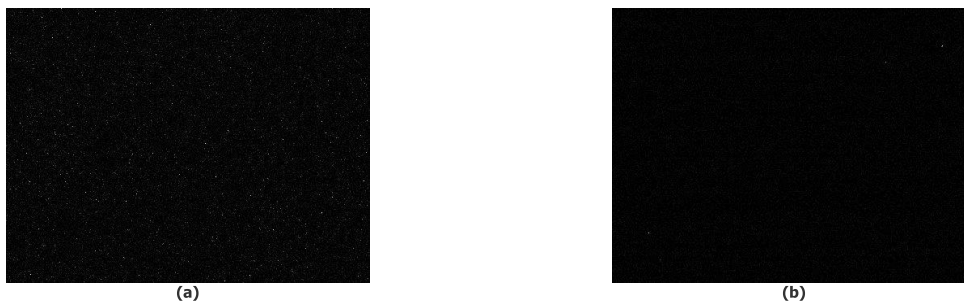

Figure 3: Images of the "star field" pattern that results from hot pixels using our (a) standard non-cooled camera and (b) our camera cooled to -20 °C. Both images were taken with an exposure of 10 seconds and with a gain of 32 dB (to make the hot pixels more visible). Please note that in order to show the pattern the images displayed here were cropped from the full-resolution 16 bit images. The full size 16 bit images may be downloaded here and viewed with software such as ImageJ, which is a free download.

INTERFACE

Thorlabs offers two interface options across our scientific camera product line: USB 3.0 and Gigabit Ethernet (GigE). Once other camera decisions, such as field of view and frame rates, have been made, for many of our camera types it is necessary to choose one of these interfaces. It is important to confirm that the computer system meets or exceeds the recommended requirements listed to the right; otherwise, dropped frames may result, particularly when streaming camera images directly to storage media.

Definitions

- **Camera Frame Rate:** The number of images per second generated by the camera. It is a function of camera model and user-selected settings.
- **Effective Frame Rate:** The number of images per second received by the host computer's camera software. This depends on the limits of the selected interface hardware (chipset), CPU performance, and other devices and software competing for the host computer resources.
- **Maximum Bandwidth:** The maximum rate (in bits/second or bytes/second) at which data can be reliably transferred over the interface from the camera to the host PC. The maximum bandwidth is a specified performance benchmark of the interface, under the assumption that the host PC is capable of receiving and handling data at that rate. An interface with a higher maximum bandwidth will typically support higher camera frame rates, but the choice of interface does not by itself increase the frame rate of the camera.

USB 3.0

USB 3.0 is a standard interface available on most new PCs, which means that typically no additional hardware is required, and therefore these cameras are not sold with any computer hardware. For users with PCs that do not have a USB 3.0 port, a PCIe card is sold separately below. USB 3.0 supports a speed up to 320 MB/s and cable lengths up to 3 m. Support for multiple cameras is possible using multiple USB 3.0 ports on the PC or a USB 3.0 hub.



Gigabit Ethernet

GigE is ideal for situations requiring longer cable lengths, as well as for systems that require using multiple cameras with one computer. GigE supports a speed up to 100 MB/s and cable lengths up to 100 m. It also uses fairly inexpensive cables, but does require the use of a computer with a GigE card installed. Support for multiple cameras is easily achieved using a Gigabit Ethernet switch. However, the GigE card supplied with the camera is recognized as a public connection to the network; institutions with strict policies only allow registered devices and trusted connections. For any questions regarding using our GigE card at your institution, please contact your IT department.

Recommended System Requirements	
Operating System	Windows® 7, 8.1, or 10 (64 bit)
Processor (CPU) ^a	≥3.0 GHz Intel Core i5, i7, or i8
Memory (RAM)	≥8 GB
Hard Drive	≥500 GB (SATA) Solid State Drive (SSD) ^b
Graphics Card	Dedicated ^c Adapter with ≥256 MB RAM
Power Supply	≥600 W
Motherboard	USB 3.0 (-USB) Cameras: Integrated Intel USB 3.0 Controller or One Unused PCIe x1 Slot (for Item # USB3-PCIE) GigE (-GE) Cameras: One Unused PCIe x1 Slot
Connectivity	USB or Internet Connectivity for Driver Installation

- Intel Core i3 processors and mobile versions of Intel processors may not satisfy the requirements.
- We recommend a solid state drive (SSD) for reliable streaming to disk during image sequence storage.
- On-board/integrated graphics solutions present on Intel Core i5 and i7 processors are also acceptable.

Scientific Camera Interface Summary

Interface	USB 3.0	Gigabit Ethernet
Interface Image (Click to Enlarge)		
Maximum Cable Length	3 m	100 m
Maximum Bandwidth ^a	320 MB/s	100 MB/s
Support for Multiple Cameras	Via Multiple USB 3.0 Ports or Hub	Via Switch Topology (Click for Details) ^b
Available Cameras	200 Frames per Second Scientific-Grade CCD Cameras 1.4 Megapixel Scientific-Grade CCD Cameras 4 Megapixel Scientific-Grade CCD Cameras 8 Megapixel Scientific-Grade CCD Cameras	

- Performance will vary depending on the exact PC configuration.
- Up to 4 cameras have been tested in the GigE switch topology.

TRIGGERING

Triggered Camera Operation

Our scientific cameras have three externally triggered operating modes: streaming overlapped exposure, asynchronous triggered acquisition, and bulb exposure driven by an externally generated trigger pulse. The trigger modes operate independently of the readout (e.g., 20 or 40 MHz; binning) settings as well as gain and offset. Figures 1 through 3 show the timing diagrams for these trigger modes, assuming an active low external TTL trigger.

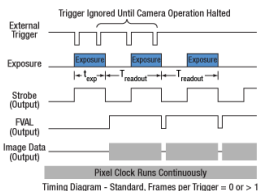

Figure 1: Streaming overlapped exposure mode. When the external trigger goes low, the exposure begins, and continues for the software-selected exposure time, followed by the readout. This sequence then repeats at the set time interval. Subsequent external triggers are ignored until the camera operation is halted.

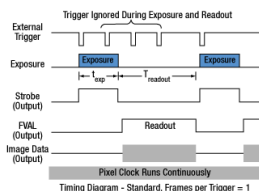

Figure 2: Asynchronous triggered acquisition mode. When the external trigger signal goes low, an exposure begins for the preset time, and then the exposure is read out of the camera. During the readout time, the external trigger is ignored. Once a single readout is complete, the camera will begin the next exposure only when the external trigger signal goes low.

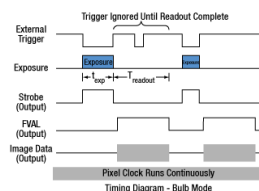

Figure 3: Bulb exposure mode. The exposure begins when the external trigger signal goes low and ends when the external trigger signal goes high. Trigger signals during camera readout are ignored.

External triggering enables these cameras to be easily integrated into systems that require the camera to be synchronized to external events. The Strobe Output goes high to indicate exposure; the strobe signal may be used in designing a system to synchronize external devices to the camera exposure. External triggering requires a connection to the auxiliary port of the camera. We offer the 8050-CAB1 auxiliary cable as an optional accessory. Two options are provided to "break out" individual signals. The TSI-IOBOB provides SMA connectors for each individual signal. Alternately, the TSI-IOBOB2 also provides the SMA connectors with the added functionality of a shield for Arduino boards that allows control of other peripheral equipment. More details on these three optional accessories are provided below.

Trigger settings are adjusted using the ThorCam software. Figure 4 shows the Camera Settings window, with the trigger settings highlighted with red and blue squares. Settings can be adjusted as follows:

- **"HW Trigger" (Red Highlight) Set to "None"**: The camera will simply acquire the number of frames in the "Frames per Trigger" box when the capture button is pressed in ThorCam.
- **"HW Trigger" Set to "Standard"**: There are Two Possible Scenarios:
 - **"Frames per Trigger" (Blue Highlight) Set to Zero or >1**: The camera will operate in streaming overlapped exposure mode (Figure 1).
 - **"Frames per Trigger" Set to 1**: Then the camera will operate in asynchronous triggered acquisition mode (Figure 2).
- **"HW Trigger" Set to "Bulb (PDX) Mode"**: The camera will operate in bulb exposure mode, also known as Pulse Driven Exposure (PDX) mode (Figure 3).

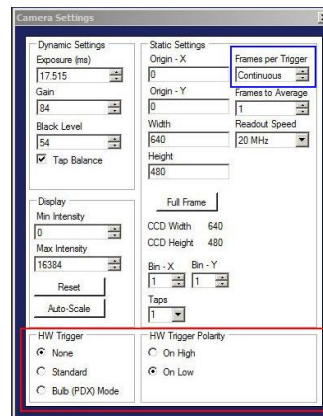

Figure 4: The ThorCam Camera Settings window. The red and blue highlighted regions indicate the trigger settings as described in the text.

In addition, the polarity of the trigger can be set to "On High" (exposure begins on the rising edge) or "On Low" (exposure begins on the falling edge) in the "HW Trigger Polarity" box (highlighted in red in Figure 4).

Example Camera Triggering Configuration using Scientific Camera Accessories

As an example of how camera triggering can be integrated into system control is shown in Figure 5. In the schematic, the camera is connected to the TSI-IOBOB2 break-out board / shield for Arduino using a 8050-CAB1 cable. The pins on the shield can be used to deliver signals to simultaneously control other peripheral devices, such as light sources, shutters, or motion control devices. Once the control program is written to the Arduino board, the USB connection to the host PC can be removed, allowing for a stand-alone system control platform; alternately, the USB connection can be left in place to allow for two-way communication between the Arduino and the PC. Configuring the external trigger mode is done using ThorCam as described above.

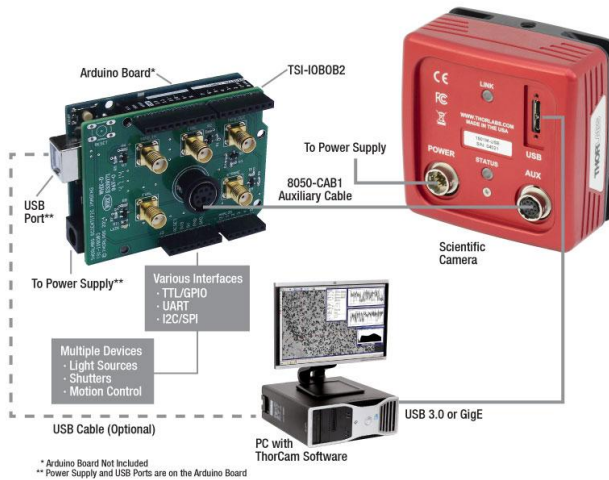

Figure 5: A schematic showing a system using the TSI-IOBOB2 to facilitate system integration and control.

Insights into Mounting Lenses to Thorlabs' Scientific Cameras

Scroll down to read about compatibility between lenses and cameras of different mount types, with a focus on Thorlabs' scientific cameras.



- Can C-mount and CS-mount cameras and lenses be used with each other?
- Do Thorlabs' scientific cameras need an adapter?
- Why can the FFD be smaller than the distance separating the camera's flange and sensor?

[Click here for more insights into lab practices and equipment.](#)

Can C-mount and CS-mount cameras and lenses be used with each other?

The C-mount and CS-mount camera system standards both include 1.000"-32 threads, but the two mount types have different flange focal distances (FFD, also known as flange focal depth, flange focal length, register, flange back distance, and flange-to-film distance). The FFD is 17.526 mm for the C-mount and 12.526 mm for the CS-mount (Figures 1 and 2, respectively).

Since their flange focal distances are different, the C-mount and CS-mount components are not directly interchangeable. However, with an adapter, it is possible to use a C-mount lens with a CS-mount camera.

Mixing and Matching

C-mount and CS-mount components have identical threads, but lenses and cameras of different mount types should not be directly attached to one another. If this is done, the lens' focal plane will not coincide with the camera's sensor plane due to the difference in FFD, and the image will be blurry.

With an adapter, a C-mount lens can be used with a CS-mount camera (Figures 3 and 4). The adapter increases the separation between the lens and the camera's sensor by 5.0 mm, to ensure the lens' focal plane aligns with the camera's sensor plane.

In contrast, the shorter FFD of CS-mount lenses makes them incompatible for use with C-mount cameras (Figure 5). The lens and camera housings prevent the lens from mounting close enough to the camera sensor to provide an in-focus image, and no adapter can bring the lens closer.

It is critical to check the lens and camera parameters to determine whether the components are compatible, an adapter is required, or the components cannot be made compatible.

1.000"-32 Threads

Imperial threads are properly described by their diameter and the number of threads per inch (TPI). In the case of both these mounts, the thread diameter is 1.000" and the TPI is 32. Due to the prevalence of C-mount devices, the 1.000"-32 thread is sometimes referred to as a "C-mount thread." Using this term can cause confusion, since CS-mount devices have the same threads.

Measuring Flange Focal Distance

Measurements of flange focal distance are given for both lenses and cameras. In the case of lenses, the FFD is measured from the lens' flange surface (Figures 1 and 2) to its focal plane. The flange surface follows the lens' planar back face and intersects the base of the external 1.000"-32 threads. In cameras, the FFD is measured from the camera's front face to the sensor plane. When the lens is mounted on the camera without an adapter, the flange surfaces on the camera front face and lens back face are brought into contact.

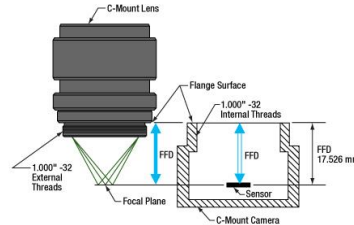

[Click to Enlarge](#)

Figure 1: C-mount lenses and cameras have the same flange focal distance (FFD), 17.526 mm. This ensures light through the lens focuses on the camera's sensor. Both components have 1.000"-32 threads, sometimes referred to as "C-mount threads".

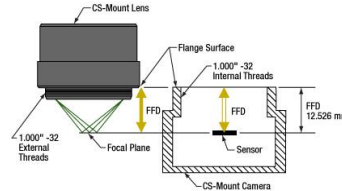

[Click to Enlarge](#)

Figure 2: CS-mount lenses and cameras have the same flange focal distance (FFD), 12.526 mm. This ensures light through the lens focuses on the camera's sensor. Their 1.000"-32 threads are identical to threads on C-mount components, sometimes referred to as "C-mount threads."

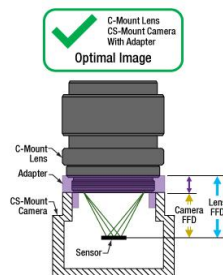

[Click to Enlarge](#)

Figure 4: An adapter with the proper thickness moves the C-mount lens away from the CS-mount camera's sensor by an optimal amount, which is indicated by the length of the purple arrow. This allows the lens to focus light on the camera's sensor, despite the difference in FFD.

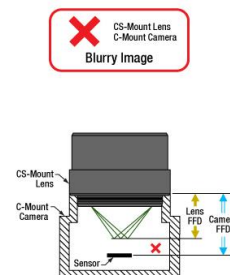

[Click to Enlarge](#)

Figure 5: A CS-mount lens is not directly compatible with a C-mount camera, since the light focuses before the camera's sensor. Adapters are not useful, since the solution would require shrinking the flange focal distance of the camera (blue arrow).

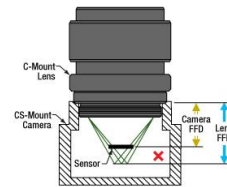

Click to Enlarge

Figure 3: A C-mount lens and a CS-mount camera are not directly compatible, since their flange focal distances, indicated by the blue and yellow arrows, respectively, are different. This arrangement will result in blurry images, since the light will not focus on the camera's sensor.

Date of Last Edit: July 21, 2020

Do Thorlabs' scientific cameras need an adapter?

All Kiralux™ and Quantalux® scientific cameras are factory set to accept C-mount lenses. When the attached C-mount adapters are removed from the passively cooled cameras, the SM1 (1.035"-40) internal threads in their flanges can be used. The Zelux scientific cameras also have SM1 internal threads in their mounting flanges, as well as the option to use a C-mount or CS-mount adapter.

The SM1 threads integrated into the camera housings are intended to facilitate the use of lens assemblies created from Thorlabs components. Adapters can also be used to convert from the camera's C-mount configurations. When designing an application-specific lens assembly or considering the use of an adapter not specifically designed for the camera, it is important to ensure that the flange focal distances (FFD) of the camera and lens match, as well as that the camera's sensor size accommodates the desired field of view (FOV).

Made for Each Other: Cameras and Their Adapters

Fixed adapters are available to configure the Zelux cameras to meet C-mount and CS-mount standards (Figures 6 and 7). These adapters, as well as the adjustable C-mount adapters attached to the passively cooled Kiralux and Quantalux cameras, were designed specifically for use with their respective cameras.

While any adapter converting from SM1 to 1.000"-32 threads makes it possible to attach a C-mount or CS-mount lens to one of these cameras, not every thread adapter aligns the lens' focal plane with a specific camera's sensor plane. In some cases, no adapter can align these planes. For example, of these scientific cameras, only the Zelux can be configured for CS-mount lenses.

The position of the lens' focal plane is determined by a combination of the lens' FFD, which is measured in air, and any refractive elements between the lens and the camera's sensor. When light focused by the lens passes through a refractive element, instead of just travelling through air, the physical focal plane is shifted to longer distances by an amount that can be calculated. The adapter must add enough separation to compensate for both the camera's FFD, when it is too short, and the focal shift caused by any windows or filters inserted between the lens and sensor.

Flexibility and Quick Fixes: Adjustable C-Mount Adapter

Passively cooled Kiralux and Quantalux cameras consist of a camera with SM1 internal threads, a window or filter covering the sensor and secured by a retaining ring, and an adjustable C-mount adapter.

A benefit of the adjustable C-mount adapter is that it can tune the spacing between the lens and camera over a 1.8 mm range, when the window / filter and retaining ring are in place. Changing the spacing can compensate for different effects that otherwise misalign the camera's sensor plane and the lens' focal plane. These effects include material expansion and contraction due to temperature changes, positioning errors from tolerance stacking, and focal shifts caused by a substitute window or filter with a different thickness or refractive index.

Adjusting the camera's adapter may be necessary to obtain sharp images of objects at infinity. When an object is at infinity, the incoming rays are parallel, and location of the focus defines the FFD of the lens. Since the actual FFDs of lenses and cameras may not match their intended FFDs, the focal plane for objects at infinity may be shifted from the sensor plane, resulting in a blurry image.

If it is impossible to get a sharp image of objects at infinity, despite tuning the lens focus, try adjusting the camera's adapter. This can compensate for shifts due to tolerance and environmental effects and bring the image into focus.

Date of Last Edit: Aug. 2, 2020

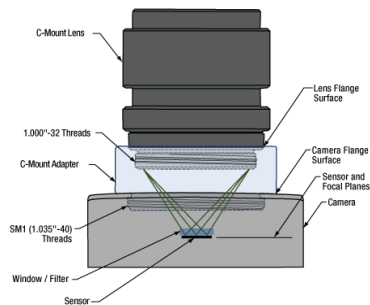

Click to Enlarge

Figure 6: An adapter can be used to optimally position a C-mount lens on a camera whose flange focal distance is less than 17.526 mm. This sketch is based on a Zelux camera and its SM1A10Z adapter.

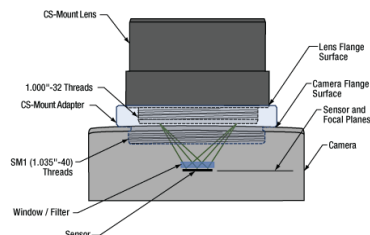

Click to Enlarge

Figure 7: An adapter can be used to optimally position a CS-mount lens on a camera whose flange focal distance is less than 12.526 mm. This sketch is based on a Zelux camera and its SM1A10 adapter.

Why can the FFD be smaller than the distance separating the camera's flange and sensor?

Flange focal distance (FFD) values for cameras and lenses assume only air fills the space between the lens and the camera's sensor plane. If windows and / or filters are inserted between the lens and camera sensor, it may be necessary to increase the distance separating the camera's flange and sensor planes to a value beyond the specified FFD. A span equal to the FFD may be too short, because refraction through windows and filters bends the light's path and shifts the focal plane farther away.

If making changes to the optics between the lens and camera sensor, the resulting focal plane shift should be calculated to determine whether the separation between lens and camera should be adjusted to maintain good alignment. Note that good alignment is necessary for, but cannot guarantee, an in-focus image, since new optics may introduce aberrations and other effects resulting in unacceptable image quality.

Equations for Calculating the Focal Shift (Δf)	
Angle of Ray in Air, from Lens f-Number (f/N)	$\theta_o = \tan^{-1}\left(\frac{1}{2N}\right)$
Change in Distance to Axis, Travelling through Air (Figure 8)	$h_o = d \tan \theta_o$
Angle of Ray to Axis, in the Medium (Figure 9)	$\theta_m = \sin^{-1}\left(\frac{n_o}{n_m} \sin \theta_o\right)$
Change in Distance to Axis, Travelling through Optic (Figure 9)	$h_m = d \tan \theta_m$
Focal Shift Caused by Refraction through Medium (Figure 9)	Exact Calculation $\Delta f = \frac{h_o - h_m}{\tan \theta_o}$
	Paraxial Approximation $\Delta f \approx d\left(1 - \frac{n_o}{n_m}\right)$

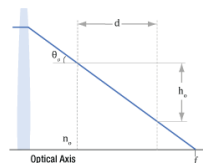

Click to Enlarge
Figure 8: A ray travelling through air intersects the optical axis at point f . The ray is h_o closer to the axis after it travels across distance d . The refractive index of the air is n_o .

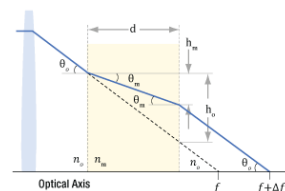

Click to Enlarge
Figure 9: Refraction causes the ray's angle with the optical axis to be shallower in the medium than in air (θ_m vs. θ_o), due to the differences in refractive indices (n_m vs. n_o). After travelling a distance d in the medium, the ray is only h_m closer to the axis. Due to this, the ray intersects the axis Δf beyond the f point.;

Example of Calculating Focal Shift		
Known Information		
C-Mount FFD	f	17.526 mm
Total Glass Thickness	d	~1.6 mm
Refractive Index of Air	n_o	1
Refractive Index of Glass	n_m	1.5
Lens f-Number	f/N	$f/1.4$
Parameter to Calculate	Exact Equations	Paraxial Approximation
θ_o	20°	
h_o	0.57 mm	---
θ_m	13°	---
h_m	0.37 mm	---
Δf	0.57 mm	0.53 mm
$f + \Delta f$	18.1 mm	18.1 mm

A Case of the Bends: Focal Shift Due to Refraction

While travelling through a solid medium, a ray's path is straight (Figure 8). Its angle (θ_o) with the optical axis is constant as it converges to the focal point (f). Values of FFD are determined assuming this medium is air.

When an optic with plane-parallel sides and a higher refractive index (n_m) is placed in the ray's path, refraction causes the ray to bend and take a shallower angle (θ_m) through the optic. This angle can be determined from Snell's law, as described in the table and illustrated in Figure 9.

While travelling through the optic, the ray approaches the optical axis at a slower rate than a ray travelling the same distance in air. After exiting the optic, the ray's angle with the axis is again θ_o , the same as a ray that did not pass through the optic. However, the ray exits the optic farther away from the axis than if it had never passed through it. Since the ray refracted by the optic is farther away, it crosses the axis at a point shifted Δf beyond the other ray's crossing. Increasing the optic's thickness widens the separation between the two rays, which increases Δf .

To Infinity and Beyond

It is important to many applications that the camera system be capable of capturing high-quality images of objects at infinity. Rays from these objects are parallel and focused to a point closer to the lens than rays from closer objects (Figure 9). The FFDs of cameras and lenses are defined so the focal point of rays from infinitely distant objects will align with the camera's sensor plane. When a lens has an adjustable focal range, objects at infinity are in focus at one end of the range and closer objects are in focus at the other.

Different effects, including temperature changes and tolerance stacking, can result in the lens and / or camera not exactly meeting the FFD specification. When the lens' actual FFD is shorter than the camera's, the camera system can no longer obtain sharp images of objects at infinity (Figure 11). This offset can also result if an optic is removed from between the lens and camera sensor.

An approach some lenses use to compensate for this is to allow the user to vary the lens focus to points "beyond" infinity. This does not refer to a physical distance, it just allows the lens to push its focal plane farther away. Thorlabs' Kiralux™ and Quantalux® cameras include adjustable C-mount adapters to allow the spacing to be tuned as needed.

If the lens' FFD is larger than the camera's, images of objects at infinity fall within the system's focal range, but some closer objects that should be within this range will be excluded. This situation can be caused by inserting optics between the lens and camera sensor. If objects at infinity can still be imaged, this can often be acceptable.

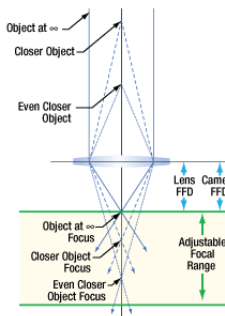

Click to Enlarge
Figure 10: When their flange focal distances (FFD) are the same, the camera's sensor plane and the lens' focal plane are perfectly aligned. Images of objects at infinity coincide with one limit of the system's focal range.

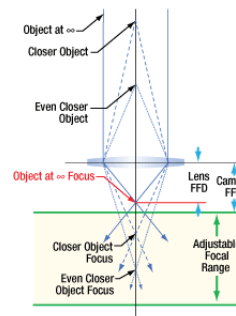

Click to Enlarge
Figure 11: Tolerance and / or temperature effects may result in the lens and camera having different FFDs. If the FFD of the lens is shorter, images of objects at infinity will be excluded from the focal range. Since the system cannot focus on them, they will be blurry.

Not Just Theory: Camera Design Example

The C-mount, hermetically sealed, and TE-cooled Quantalux camera has a fixed 18.1 mm spacing between its flange surface and sensor plane. However, the FFD (f) for C-mount camera systems is 17.526 mm. The camera's need for greater spacing becomes apparent when the focal shift due to the window soldered into the hermetic cover and the glass covering the sensor are taken into account. The results recorded in the table beneath Figure 9 show that both exact and paraxial equations return a required total spacing of 18.1 mm.



Date of Last Edit: July 31, 2020

Selection Guide

Thorlabs offers four families of scientific cameras: Zelux™, Kiralux®, Quantalux®, and Scientific CCD. Zelux cameras are designed for general-purpose imaging and provide high imaging performance while maintaining a small footprint. Kiralux cameras have CMOS sensors in monochrome, color, NIR-enhanced, or polarization-sensitive versions and are available in compact, passively cooled housings; the CC505MU camera incorporates a hermetically sealed, TE-cooled housing. The polarization-sensitive Kiralux camera incorporates an integrated micropolarizer array that, when used with our ThorCam™ software package, captures images that illustrate degree of linear polarization, azimuth, and intensity at the pixel level. Our Quantalux monochrome sCMOS cameras feature high dynamic range combined with extremely low read noise for low-light applications. They are available in either a compact, passively cooled housing or a hermetically sealed, TE-cooled housing. We also offer scientific CCD cameras with a variety of features, including versions optimized for operation at UV, visible, or NIR wavelengths; fast-frame-rate cameras; TE-cooled or non-cooled housings; and versions with the sensor face plate removed. The tables below provide a summary of our camera offerings.

Want to Learn More?
View Our Recorded Webinar
[Click Here](#)



Compact Scientific Cameras							
Camera Type	Zelux™ CMOS	Kiralux® CMOS					Quantalux® sCMOS
	1.6 MP	1.3 MP	2.3 MP	5 MP	8.9 MP	12.3 MP	2.1 MP
Item #	Monochrome: CS165MU ^a Color: CS165CU ^a	Mono.: CS135MU Color: CS135CU NIR-Enhanced Mono.: CS135MUN	Mono.: CS235MU Color: CS235CU	Mono., Passive Cooling: CS505MU Active Cooling: CC505MU Color: CS505CU Polarization: CS505MUP	Mono., Passive Cooling: CS895MU Mono., Active Cooling: CC895MU Color: CS895CU	Mono.: CS126MU Color: CS126CU	Monochrome, Passive Cooling: CS2100M-USB Active Cooling: CC215MU
Product Photos (Click to Enlarge)							
Electronic Shutter	Global Shutter	Global Shutter					Rolling Shutter ^b
Sensor Type	CMOS	CMOS					sCMOS
Number of Pixels (H x V)	1440 x 1080	1280 x 1024	1920 x 1200	2448 x 2048	4096 x 2160	4096 x 3000	1920 x 1080
Pixel Size	3.45 μm x 3.45 μm	4.8 μm x 4.8 μm	5.86 μm x 5.86 μm	3.45 μm x 3.45 μm			5.04 μm x 5.04 μm
Optical Format	1/2.9" (6.2 mm Diag.)	1/2" (7.76 mm Diag.)	1/1.2" (13.4 mm Diag.)	2/3" (11 mm Diag.)	1" (16 mm Diag.)	1.1" (17.5 mm Diag.)	2/3" (11 mm Diag.)
Peak Quantum Efficiency (Click for Plot)	Monochrome: 69% at 575 nm Color: Click for Plot	Monochrome: 59% at 550 nm Color: Click for Plot NIR: 60% at 600 nm	Monochrome: 78% at 500 nm Color: Click for Plot	Monochrome & Polarization: 72% (525 to 580 nm) Color: Click for Plot	Monochrome: 72% (525 to 580 nm) Color: Click for Plot	Monochrome: 72% (525 to 580 nm) Color: Click for Plot	Monochrome: 61% (at 600 nm)
Max Frame Rate (Full Sensor)	34.8 fps	92.3 fps	39.7 fps	35 fps	20.8 fps	21.7 fps	50 fps
Read Noise	<4.0 e ⁻ RMS	<7.0 e ⁻ RMS	<7.0 e ⁻ RMS	<2.5 e ⁻ RMS			<1 e ⁻ Median RMS; <1.5 e ⁻ RMS
Digital Output	10 Bit (Max)	10 Bit (Max)	12 Bit (Max)				16 Bit (Max)
PC Interface	USB 3.0						
Available Fanless Cooling	N/A	N/A	N/A	0 °C at 20 °C Ambient (CC505MU Only)	0 °C at 20 °C Ambient (CC895MU Only)	N/A	0 °C at 20 °C Ambient (CC215MU Only)
Housing Size (Click for Details)	0.59" x 1.72" x 1.86" (15.0 x 43.7 x 47.2 mm ³)	Passively Cooled CMOS Camera TE-Cooled CMOS Camera					Passively Cooled sCMOS Camera TE-Cooled sCMOS Camera

Compact Scientific Cameras							
Camera Type	Zelux™ CMOS	Kiralux® CMOS					Quantalux® sCMOS
	1.6 MP	1.3 MP	2.3 MP	5 MP	8.9 MP	12.3 MP	2.1 MP
Typical Applications	General Purpose Imaging, Brightfield Microscopy, Machine Vision & Robotics, UAV, Drone, & Handheld Imaging, Inspection, Monitoring	VIS/NIR Imaging, Electrophysiology/Brain Slice Imaging, Materials Inspection, Multispectral Imaging, Ophthalmology/Retinal Imaging, Vascular Imaging, Laser Speckle Imaging, Semiconductor Inspection, Fluorescence Microscopy, Brightfield Microscopy	Fluorescence Microscopy, Immunohistochemistry, Machine Vision, Inspection, General Purpose Imaging	Mono. & Color: Fluorescence Microscopy, Immunohistochemistry, Machine Vision & Inspection Polarization: Machine Vision & Inspection, Transparent Material Detection, Surface Reflection Reduction	Fluorescence Microscopy, Immunohistochemistry, Large FOV Slide Imaging, Machine Vision, Inspection		Fluorescence Microscopy, VIS/NIR Imaging, Quantum Dots, Autofluorescence, Materials Inspection, Multispectral Imaging

- These item numbers are representative of the Zelux family. These cameras are available with or without external hardware triggers.
- Rolling Shutter with Equal Exposure Pulse (EEP) Mode for Synchronizing the Camera and Light Sources for Even Illumination

Scientific CCD Cameras						
Camera Type	Fast Frame Rate VGA CCD		1.4 MP CCD	4 MP CCD	8 MP CCD	
Item # Prefix	Monochrome: 340M	UV-Enhanced Monochrome: 340UV	Monochrome: 1501M Color: 1501C	Monochrome: 4070M Color: 4070C	Monochrome: 8051M Color: 8051C	Monochrome, No Sensor Face Plate: S805MU
Product Photo (Click to Enlarge)						
Electronic Shutter	Global Shutter					
Sensor Type	CCD					
Number of Pixels (H x V)	640 x 480		1392 x 1040	2048 x 2048	3296 x 2472	
Pixel Size	7.4 μm x 7.4 μm		6.45 μm x 6.45 μm	7.4 μm x 7.4 μm	5.5 μm x 5.5 μm	
Optical Format	1/3" (5.92 mm Diagonal)		2/3" (11 mm Diagonal)	4/3" (21.4 mm Diagonal)	4/3" (22 mm Diagonal)	
Peak QE (Click for Plot)	55% at 500 nm	10% at 485 nm	Monochrome: 60% at 500 nm Color: Click for Plot	Monochrome: 52% at 500 nm Color: Click for Plot	Monochrome: 51% at 460 nm Color: Click for Plot	51% at 460 nm
Max Frame Rate (Full Sensor)	200.7 fps (at 40 MHz Dual-Tap Readout)		23 fps (at 40 MHz Single-Tap Readout)	25.8 fps (at 40 MHz Quad-Tap Readout) ^a	17.1 fps (at 40 MHz Quad-Tap Readout) ^b	17.1 fps (at 40 MHz Quad-Tap Readout)
Read Noise	<15 e ⁻ at 20 MHz		<7 e ⁻ at 20 MHz (Standard Models) <6 e ⁻ at 20 MHz (-TE Models)	<12 e ⁻ at 20 MHz	<10 e ⁻ at 20 MHz	
Digital Output (Max)	14 Bit ^c		14 Bit	14 Bit ^c		14 Bit
Available Fanless Cooling	Passive Thermal Management		-20 °C at 20 °C Ambient Temperature		-10 °C at 20 °C Ambient	
Available PC Interfaces	USB 3.0 or Gigabit Ethernet					USB 3.0
Housing Dimensions (Click for Details)	Non-Cooled Scientific CCD Camera		Cooled Scientific CCD Camera Non-Cooled Scientific CCD Camera			No Face Plate Scientific CCD Camera
Typical Applications	Ca ⁺⁺ Ion Imaging, Particle Tracking, Flow Cytometry, SEM/EBSD, UV Inspection		Fluorescence Microscopy, VIS/NIR Imaging, Quantum Dots, Multispectral Imaging, Immunohistochemistry (IHC), Retinal Imaging	Fluorescence Microscopy, Transmitted Light Microscopy, Whole-Slide Microscopy, Electron Microscopy (TEM/SEM), Inspection, Material Sciences	Fluorescence Microscopy, Whole-Slide Microscopy, Large FOV Slide Imaging, Histopathology, Inspection, Multispectral Imaging, Immunohistochemistry (IHC)	
	Beam Profiling & Characterization, Interferometry, VCSEL Inspection, Quantitative Phase-Contrast Microscopy, Ptychography, Digital Holographic Microscopy					

- Limited to 13 fps at 40 MHz dual-tap readout for Gigabit Ethernet cameras; quad-tap readout is unavailable for Gigabit Ethernet cameras.
- Limited to 8.5 fps at 40 MHz dual-tap readout for Gigabit Ethernet cameras; quad-tap readout is unavailable for Gigabit Ethernet cameras.
- Gigabit Ethernet cameras operating in dual-tap readout mode are limited to 12-bit digital output.

8 MP Scientific CCD Cameras

- ▶ Compact, Non-Cooled Standard Package
- ▶ Recommended for Applications with High Light Levels that Require Exposure Times <1 second
- ▶ Available with Either a USB 3.0 or Gigabit Ethernet (GigE)

Our 8 megapixel scientific cameras are offered with monochrome or color sensors in a compact, non-cooled standard package. These cameras are ideal for applications with high light levels that require short exposure times (less than 1 second).

For mounting, the front end has standard C-Mount (1.000"-32) threading, and Thorlabs provides a full line of thread-to-thread adapters for compatibility with other thread standards, including the SM1 (1.035"-40) threading used on our Ø1"

Lens Tubes. Four 4-40 tapped holes on the front face of these cameras provide compatibility with our 60 mm Cage System. Four 1/4"-20 tapped holes, one on each side of the housing, are compatible with our Ø1" posts. These flexible mounting options make Thorlabs' cameras the ideal choice for integrating into home-built imaging systems or commercial microscopes.



Click to Enlarge
GE Camera Integrated into
60 mm Cage System



Click to Enlarge
USB Camera with MVL25M23
C-Mount Camera Lens

**Limited
Stock**

Please note that On Semiconductor has announced that the CCD sensors used in Thorlabs Scientific CCD cameras will be discontinued in June 2020. Thorlabs will continue to manufacture these cameras into 2021. While these sensors are still widely available, we do not recommend these devices for new designs. Please see our expanding line of compact sCMOS and CMOS cameras for alternatives or contact our Scientific Cameras Team for help finding the best option for your application.

Applications

- Fluorescence Microscopy
- Transmitted Light Microscopy
- Whole-Slide Microscopy
- Large FOV Slide Imaging
- Histopathology
- Inspection
- Multispectral Imaging
- Immunohistochemistry (IHC)

Monochrome Item #^{a,b}	8051M-USB	8051M-GE
Color Item #^{a,b}	8051C-USB	8051C-GE
Number of Active Pixels	3296 x 2472 (Horizontal x Vertical)	
Pixel Size	5.5 µm x 5.5 µm	
Quantum Efficiency (Click for Graphs)	Monochrome ^c Color ^d	
Number of Taps (Software Selectable)	Single, Dual, Quad	Single, Dual
Digital Output	14 Bit	Single Tap: 14 Bit Dual-Tap: 12 Bit
Cooling	No	
Host PC Interface^e	USB 3.0	Gigabit Ethernet
Built in Optics^f (Click for Graph)	IR Blocking Filter	

- The specified performance is valid when using a computer with the recommended specifications listed on the *Interface* tab.
- Please see the *Specs* tab for a complete list of specifications.
- Click here for monochrome camera QE raw data.
- Click here for color camera QE raw data.
- For more information on these interface options, please see the *Interface* tab.
- Click here for IR blocking filter transmission raw data.

Part Number	Description	Price	Availability
8051M-USB	8 MP Monochrome CCD Camera, Standard Package, USB 3.0 Interface	\$7,212.00	Today
8051C-USB	8 MP Color CCD Camera, Standard Package, USB 3.0 Interface	\$7,212.00	5-8 Days
8051M-GE	8 MP Monochrome CCD Camera, Standard Package, GigE Interface	\$7,212.00	Today
8051C-GE	8 MP Color CCD Camera, Standard Package, GigE Interface	\$7,212.00	Today

8 MP Scientific CCD Cameras, Sensor Face Plate Removed

- ▶ Compact, Non-Cooled Standard Package with the Sensor Face Plate Removed
- ▶ Recommended for Applications Highly Sensitive to Interference Patterns
- ▶ Available with a USB 3.0 Interface

- Applications**
- Beam Profiling & Characterization
 - Interferometry
 - VCSEL Inspection
 - Quantitative Phase-Contrast Microscopy
 - Ptychography
 - Digital Holographic Microscopy

The S805MU scientific CCD cameras are versions of our 8051M-USB camera with the sensor face plate removed and the NIR filter replaced with a wedged window. These models are ideal for inspection and other applications that are sensitive to interference patterns caused by reflections from the sensor face plate. Each camera has only an AR-coated wedged window in front of the sensor. The S805MU1 camera contains a WW11050-C7 wedged window coated for 400 - 700 nm, while the S805MU2 camera contains a WW11050-C13 wedged window coated for 700 - 1100 nm. The optical front end should never be disassembled as this could result in damage to the sensor. For custom applications that require a different optic than the wedged window, please contact Tech Support.

The front face of these cameras features 4-40 tapped holes for compatibility with our 60 mm Cage System. Four 1/4"-20 tapped holes, one on each side of the housing, are compatible with our Ø1" posts. These models do not feature C-mount threading, but the front end does have 1.375"-32 threading for users interested in designing custom mounts.

Monochrome Item # ^{a,b}	S805MU1	S805MU2
Number of Active Pixels	3296 x 2472 (Horizontal x Vertical)	
Pixel Size	5.5 µm x 5.5 µm	
Quantum Efficiency (Click for Graph)	Monochrome ^c	
Number of Taps (Software Selectable)	Single, Dual, Quad	
Digital Output	14 Bit	
Cooling	No	
Host PC Interface^d	USB 3.0	
Built in Optics^e (Click for Graphs)	WW11050-C7 AR Coated Wedged Window (400- 700 nm)	WW11050-C13 AR Coated Wedged Window (700 - 1100 nm)

- The specified performance is valid when using a computer with the recommended specifications listed on the *Interface* tab.
- Please see the *Specs* tab for a complete list of specifications.
- Click here for monochrome camera QE raw data.
- For more information on these interface options, please see the *Interface* tab.
- Click here for wedged window reflectance raw data.

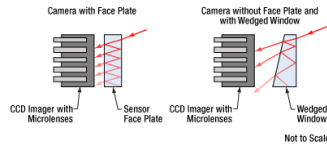

Click to Enlarge
 Removing the sensor face plate and adding a wedged window minimizes interference patterns due to etalon effects.

Limited STOCK

Please note that On Semiconductor has announced that the CCD sensors used in Thorlabs Scientific CCD cameras will be discontinued in June 2020. Thorlabs will continue to manufacture these cameras into 2021. While these sensors are still widely available, we do not

recommend these devices for new designs. Please see our expanding line of compact sCMOS and CMOS cameras for alternatives or contact our Scientific Cameras Team for help finding the best option for your application.

Part Number	Description	Price	Availability
S805MU1	Customer Inspired! 8 MP Monochrome CCD Camera, No Sensor Face Plate, 400 - 700 nm AR Coated Wedged Window, USB 3.0 Interface	\$7,300.00	Today
S805MU2	8 MP Monochrome CCD Camera, No Sensor Face Plate, 700 - 1100 nm AR Coated Wedged Window, USB 3.0 Interface	\$7,300.00	Today

8 MP Scientific CCD Cameras, Hermetically Sealed Cooled Packaging

- ▶ Hermetically Sealed Package with a Two-Stage Thermoelectric Cooler
- ▶ Recommended for Applications with Low Light Levels that Require Exposure Times >1 second
- ▶ Available with Either a USB 3.0 or Gigabit Ethernet (GigE) Interface

Applications

- Fluorescence Microscopy
- Transmitted Light Microscopy
- Whole-Slide Microscopy
- Large FOV Slide Imaging
- Histopathology
- Inspection
- Multispectral Imaging
- Immunohistochemistry (IHC)

Our 8 megapixel scientific cameras are offered with monochrome or color sensors in a hermetically sealed package with a two-stage thermoelectric cooler that cools the CCD. The fan-free design limits image blur from vibrations. Cooling the camera will reduce the dark current; however, the total dark current is also a function of exposure time. A cooled camera is only recommended for applications with low light levels requiring an exposure greater than 1 second. Please see the Camera Noise tab for more details on the various sources of camera noise and how it impacts the choice between a standard and cooled camera.

These cameras have standard C-Mount (1.000"-32) threading, and Thorlabs provides a full line of thread-to-thread adapters for compatibility with other thread standards, including the SM1 (1.035"-40) threading used on our Ø1" Lens Tubes. The front face also features 4-40 tapped holes for compatibility with our 60 mm Cage System. Four 1/4"-20 tapped holes, one on each side of the housing, are compatible with our Ø1" posts. These flexible mounting options make Thorlabs' cameras the ideal choice for integrating into home-built imaging systems or commercial microscopes.

Monochrome Item # ^{a,b}	8051M-USB-TE	8051M-GE-TE
Color Item # ^{a,b}	8051C-USB-TE	8051C-GE-TE
Number of Active Pixels	3296 x 2472 (Horizontal x Vertical)	
Pixel Size	5.5 µm x 5.5 µm	
Quantum Efficiency (Click for Graphs)	Monochrome ^c Color ^d	
Number of Taps (Software Selectable)	Single, Dual, Quad	Single, Dual
Digital Output	14 Bit	Single Tap: 14 Bit Dual-Tap: 12 Bit
Cooling	Sensor Cools to -10 °C at 20 °C Ambient Temperature	
Host PC Interface ^e	USB 3.0	Gigabit Ethernet
Built in Optics ^f (Click for Graph)	IR Blocking Filter	

- The specified performance is valid when using a computer with the recommended specifications listed on the *Interface* tab.
- Please see the *Specs* tab for a complete list of specifications.
- Click here for monochrome camera QE raw data.
- Click here for color camera QE raw data.
- For more information on these interface options, please see the *Interface* tab.
- Click here for IR blocking filter transmission raw data.



Click to Enlarge
8051M-GE-TE Camera Integrated into 60 mm Cage System

**Limited
Stock**

Please note that On Semiconductor has announced that the CCD sensors used in Thorlabs Scientific CCD cameras will be discontinued in June 2020. Thorlabs will continue to manufacture these cameras into 2021. While these sensors are still widely available, we do not recommend these devices for new designs. Please see our expanding line of compact sCMOS and CMOS cameras for alternatives or contact our Scientific Cameras Team for help finding the best option for your application.

Part Number	Description	Price	Availability
8051M-USB-TE	8 MP Monochrome CCD Camera, Hermetically Sealed Cooled Package, USB 3.0 Interface	\$10,490.18	Today
8051C-USB-TE	8 MP Color CCD Camera, Hermetically Sealed Cooled Package, USB 3.0 Interface	\$10,490.18	Lead Time
8051M-GE-TE	8 MP Monochrome CCD Camera, Hermetically Sealed Cooled package, GigE Interface	\$10,490.18	Today
8051C-GE-TE	8 MP Color CCD Camera, Hermetically Sealed Cooled Package, GigE Interface	\$10,490.18	Lead Time

Scientific Camera Optional Accessories



Click to Enlarge



Click to Enlarge

These optional accessories allow for easy use of the auxiliary port of our scientific CCD, CMOS, and Quantalux™ sCMOS cameras. These items should be considered when it is necessary to externally trigger the camera, to monitor camera performance with an oscilloscope, or for simultaneous control of the camera with other instruments.

For our USB 3.0 cameras, we also offer a PCIe USB 3.0 card and extra cables for facilitating the connection to the computer.

Auxiliary I/O Cable (8050-CAB1)

The 8050-CAB1 is a 10' (3 m) long cable that mates with the auxiliary connector on our scientific cameras* and provides the ability to externally trigger the camera as well as monitor status output signals. One end of the cable features a male 12-pin connector for connecting to the camera, while the other end has a male 6-pin Mini Din connector for connecting to external devices. This cable is ideal for use with our interconnect break-out boards described below. For

information on the pin layout, please see the *Pin Diagrams* tab above.

Interconnect Break-Out Board (TSI-IOBOB)

The TSI-IOBOB is designed to "break out" the 6-pin Mini Din connector found on our scientific camera auxiliary cables into five SMA connectors. The SMA connectors can then be connected using SMA cables to other devices to provide a trigger input to the camera or to monitor camera performance. The pin configurations are listed on the *Pin Diagrams* tab above.

Interconnect Break-Out Board / Shield for Arduino (TSI-IOBOB2)

The TSI-IOBOB2 offers the same breakout functionality of the camera signals as the TSI-IOBOB. Additionally, it functions as a shield for Arduino, by placing the TSI-IOBOB2 shield on an Arduino board supporting the Arduino Uno Rev. 3 form factor. While the camera inputs and outputs are 5 V TTL, the TSI-IOBOB2 features bi-directional logic level converters to enable compatibility with Arduino boards operating on either 5 V or 3.3 V logic. Sample programs for controlling the scientific camera are available for download from our software page, and are also described in the manual (found by clicking on the red Docs icon below). For more information on Arduino, or for information on purchasing an Arduino board, please see www.arduino.cc.

The image to the right shows a schematic of a configuration with the TSI-IOBOB2 with an Arduino board integrated into a camera imaging system. The camera is connected to the break-out board using a 8050-CAB1 cable that must be purchased separately. The pins on the shield can be used to deliver signals to simultaneously control other peripheral devices, such as light sources, shutters, or motion control devices. Once the control program is written to the Arduino board, the USB connection to the host PC can be removed, allowing for a stand-alone system control platform; alternately, the USB connection can be left in place to allow for two-way communication between the Arduino and the PC. The compact size of 2.70" x 2.10" (68.6 mm x 53.3 mm) also aids in keeping systems based on the TSI-IOBOB2 compact.

USB 3.0 Camera Accessories (USB3-MBA-118 and USB3-PCIE)

We also offer a USB 3.0 A to Micro B cable for connecting our cameras to a PC (please note that one cable is included with each USB 3.0 camera). The cable measures 118" long and features screws on either side of the Micro B connector that mate with tapped holes on the camera for securing the USB cable to the camera housing.

A USB 3.0 PCIe card is also provided for computers that do not offer USB 3.0 connectors with an integrated Intel USB 3.0 controller. However, since most newer computers offer several USB 3.0 connections, a USB 3.0 PCIe card is not included with the purchase of a USB 3.0 camera. The card has two type A USB 3.0 ports.

*The 8050-CAB1 is not compatible with our former-generation 1500M series cameras.



Click for Details

A schematic showing a TSI-IOBOB2 connected to an Arduino in a custom camera system.

Part Number	Description	Price	Availability
8050-CAB1	I/O Cable for Scientific CCD and Compact Scientific Cameras	\$76.49	Today
TSI-IOBOB	I/O Break-Out Board for Scientific CCD and Compact Scientific Cameras	\$68.96	Today
TSI-IOBOB2	Customer Inspired! I/O Break-Out Board for Scientific CCD and Compact Scientific Cameras with Shield for Arduino (Arduino Board not Included)	\$99.06	Today
USB3-MBA-118	USB 3.0 A to Micro B Cable, Length: 118" (3 m)	\$38.69	Today
USB3-PCIE	USB 3.0 PCI Express Expansion Card	\$66.28	Today

Visit the *8 Megapixel CCD Scientific Cameras for Microscopy* page for pricing and availability information:
https://www.thorlabs.com/newgrouppage9.cfm?objectgroup_id=6540

