

TEL220 - October 1, 2020

Item # TEL220 was discontinued on October 1, 2020. For informational purposes, this is a copy of the website content at that time and is valid only for the stated product.

TELESTO SERIES SD-OCT SYSTEMS

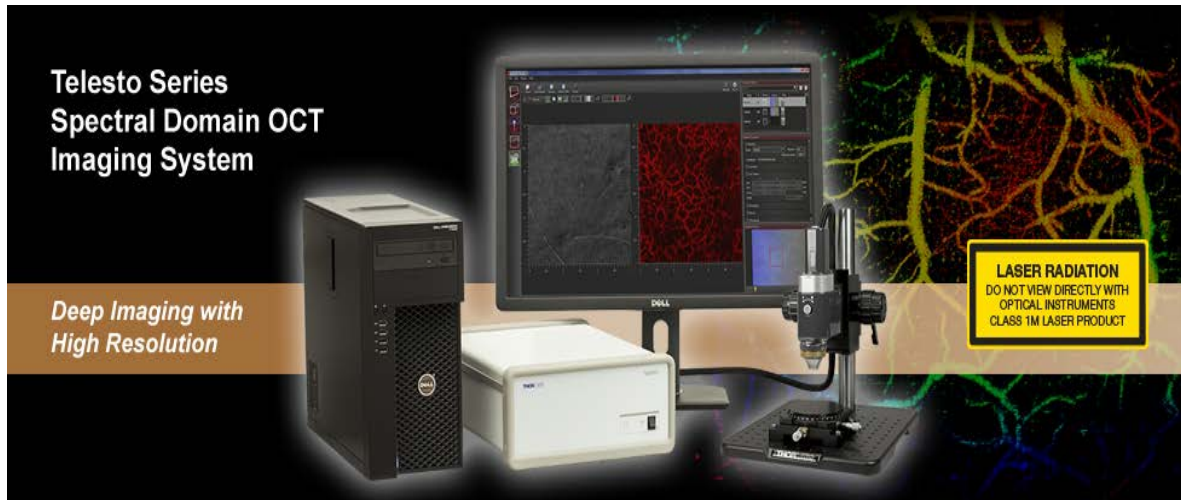

OVERVIEW

Features

- Configurable OCT Systems Optimized for High-Resolution Imaging with Deeper Penetration
 - 3.5 mm Imaging Depth with 5.5 μm Axial Resolution in Air (1300 nm Center Wavelength)
 - 7.0 mm Imaging Depth with 12.0 μm Axial Resolution in Air (1325 nm Center Wavelength)
- Base Units with A-Scan Rates up to 146 kHz Available
 - 111 dB Max Sensitivity at 5.5 kHz Scan Rate
 - 109 dB Max Sensitivity at 10 kHz Scan Rate
- Includes Computer and ThorImage[®] OCT Software Package (See the *Software* Tab)
- Build-Your-Own and Preconfigured Systems Available
- See the *Brochures* Tab for More Information on Thorlabs' OCT Systems



OCT Applications Team Based in Lübeck, Germany

We're Happy to Assist!

Exploring the Options?

We can provide recommendations based on your needs and partner with you to obtain images of samples provided by you demonstrating the effects of various components on image quality. Demos of our OCT systems can be arranged at our Sterling, VA (USA); Shanghai, China; Tokyo, Japan; and Lübeck, Germany facilities.

In the Budgetary Phase?

System prices vary based on the exact components. Through our conversations, we can ensure your system quote is tailored to your requirements.

OEM or Custom Projects?

Click here to learn about our OEM capabilities.

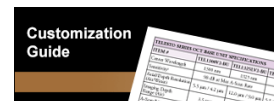

Choose Components to Build or Customize Your OCT System

- Choose from High-Resolution (1300 nm) or Long-Range (1325 nm) Base Units
- Standard, User-Customizable, and Handheld Scanners Available
- Scan Lens Kits to Optimize Lateral Resolution and Focal Length for Your Application
- Ring- and Immersion-Style Sample Z-Spacers for Air or Liquid Imaging Applications
- Scanner Stand and Translation Stage Accessories
- Contact Our OCT Team to Request a Quote and Discuss Building a System

Optical Coherence Tomography (OCT) is a noninvasive optical imaging technique that produces real-time, 2D cross-sectional and 3D volumetric images of a sample. This technique provides structural information about the sample based on light backscattered from different layers of material within that sample, producing images with micron-level resolution and millimeters of imaging depth. OCT imaging can be considered as an optical analog to ultrasound imaging that achieves higher resolution at the cost of decreased penetration depth. In addition to high resolution, the non-contact, noninvasive nature of OCT makes it well suited for imaging samples such as biological tissue, small animals, and industrial materials.

Thorlabs' Telesto OCT Imaging Systems provides the flexibility required for long-range and high-resolution imaging applications. The 64-bit software pre-installed on the included computer displays and processes 2D and 3D OCT data in real time. Choose from a number of scanner options including a robust standard scanner, user-customizable scanner, and the portable handheld scanner. Optional accessories are available below to customize your OCT system to meet the requirements of your application. Additionally, Thorlabs offers two complete, preconfigured OCT systems for 1300 nm or 1325 nm based on the components sold on this page.

The components below can also be used to upgrade your existing Thorlabs OCT system with additional features and are fully compatible out of the box with Thorlabs' OCT systems and accessories. While most systems are upgradable, we recommend contacting the OCT Team to determine the optimal solution for your system and intended application.

Click on the Image Below or in the Table to the Right for Details on Customization Options

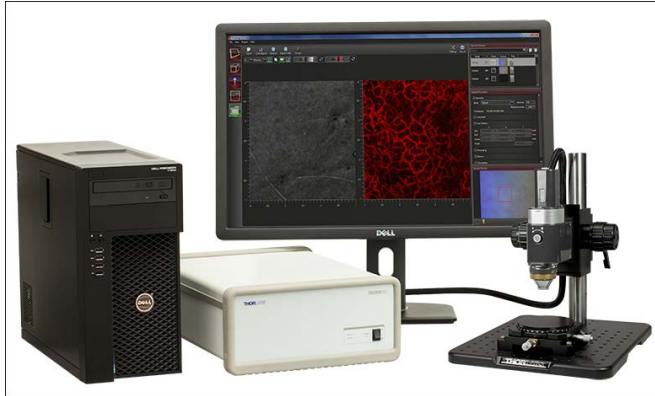

Telesto Customization Options
OCT Base Unit (Computer Included)
Scanning System
Scan Lens Kit
Reference Length Adapter (For Standard Scanners Only)
Sample Z-Spacer
Adjustable Scanner Stand
Translation Stage
Preconfigured Systems (Z-Spacer Not Included)

SOFTWARE

ThorImage®OCT Software Index

- Introduction
- Imaging Modes
 - 1D Mode for Single Point Measurements
 - 2D Mode for Cross-Sectional Imaging
 - 3D Mode for Volume Imaging
 - Doppler Mode for Doppler Flow Imaging
 - Speckle Variance Mode for Angiographic Imaging
- Externally-Triggered Acquisition for Synchronized Measurements
- Easy Probe Calibration for Different Configurations
- Video Showing Screencast of Rendering Capabilities

ThorImageOCT Software

- Interactive Scan Position Control through Video Display for Common Line Scans or Freeform Pattern Scans
- Advanced Dataset Management
- Access to Raw Spectra, Processed Data, and All Calibration Files Necessary for User-Designed Processing Routines
- High-Speed Volume Rendering of 3D Data
- Doppler and Speckle Variance Imaging
- Versatile Scan and Acquisition Control, such as Averaging or Adjustable Scan Speeds

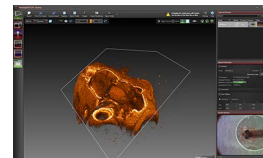

Click to Enlarge
Rendered Volume with Modifiable Clipping
Plane of a Zebrafish

ThorImageOCT is a high-performance data acquisition software, which is included with all Thorlabs OCT systems. This 64-bit Windows-based software package performs data acquisition, processing, scan control, and displays OCT images. Additionally, NI LabVIEW and C-based Software Development Kits (SDKs) are available, which contain a complete set of libraries for measurement control, data acquisition and processing, as well as storage and display of OCT images. The SDKs provide the means for developing highly specialized OCT imaging software for every individual application.

Scan Control

ThorImageOCT provides numerous scan and acquisition controls. The camera integrated in the scanner of our OCT systems provides live video images in the application software. Defining the scan line for 2D imaging or the scan area for 3D imaging is accomplished through the easy-to-use "Draw and Scan" feature by clicking on the video image.

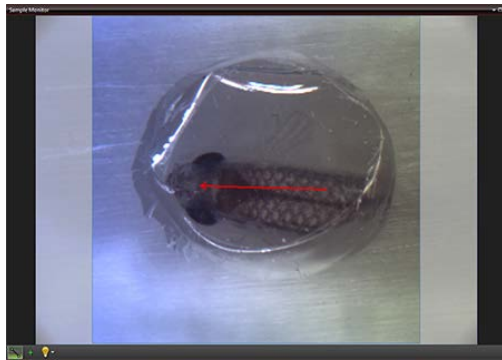

Click to Enlarge
The Sample Monitor can be used to define the scan pattern using the "Draw and Scan" feature.

Arbitrary forms defined by the Draw & Scan feature or loaded .txt files can be scanned. The scan pattern can also be adjusted by specifying suitable parameters in the controls of the software, as shown to the right.



Click to Enlarge
Various acquisition parameters can be adjusted in ThorImageOCT.

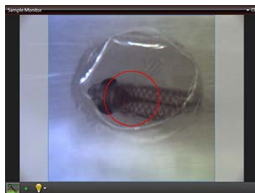

Click to Enlarge
A predefined circle scan pattern can be loaded and scanned in the software. The size can be changed with the Zoom feature.

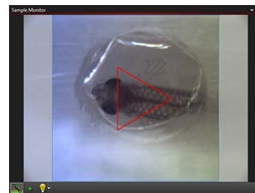

Click to Enlarge
A predefined triangle scan pattern can be loaded and scanned in the software. The size can be changed with the Zoom feature.

Additionally, one can further set processing parameters, averaging parameters, and the speed and sensitivity of the device using device presets. By using a high-speed preset, video-like frame rates in 2D and fast volume rendering in 3D are possible, whereas high-sensitivity acquisition is enabled by choosing a preset with a lower acquisition speed.

Dataset Management

ThorImageOCT provides advanced dataset management capabilities, which allow opening several datasets simultaneously. Datasets are uniquely defined using an identifier consisting of a study (or test series) name and an experiment number. Grouping of datasets can be achieved by using the same study name. The "Captured Datasets" list shows an overview of all open datasets, including the dataset identifier, the acquisition mode, and preview pictures of the still video image and the OCT data.

Datasets can be exported in various image formats, such as PNG, BMP, JPEG, PDF, or TIFF. The set can also be exported in complete data formats suited for post-processing purposes, such as RAW/SRM, FITS, VTK, VFF, and 32-bit floating-point TIFF.

The OCT file format native to ThorImageOCT allows OCT data, sample monitor data, and all relevant metadata to be stored in a single file. ThorImageOCT can also be installed and run on computers without OCT devices in order to view and export OCT data. The user has full access to the raw and processed data from the device, including additional data used for processing, e.g. offset errors.

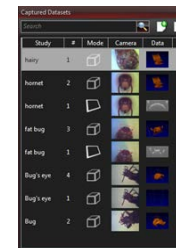

Click to Enlarge
The Dataset Management Window of ThorImageOCT

Third Party Applications

If both ImageJ and ThorImageOCT are installed on the computer, opening acquired OCT data in ImageJ is one mouse click away. This enables a flawless workflow when requiring the advanced image processing functionality provided by ImageJ. Clicking the Explorer button will open the folder and select the file in Windows Explorer where the currently active dataset is stored.

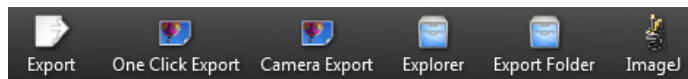

Export buttons are accessible in the Action Toolbar of ThorImageOCT.

Imaging Modes

Different OCT imaging modes can be selected using the mode selector. If the ThorImageOCT software finds a compatible system connected and switched on, all operational modes will be selectable. If no OCT device is present, only the data viewing mode for viewing and exporting OCT data will be available.

1D Mode

The 1D Mode provides the possibility to measure at a single point. The single point

measurement not only provides spectral information and depth information, but also gives the possibility to observe time related behavior of a sample with an M-Scan.

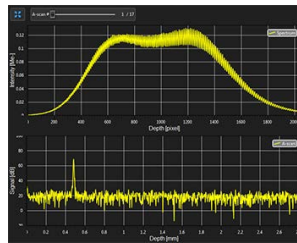

Click to Enlarge
Spectral and Depth Information for a Single Point (A-Scan)

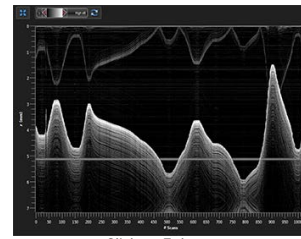

Click to Enlarge
Several A-Scans at a Single Point Over Time (M-Scan)

2D Mode

In the 2D imaging mode, the probe beam scans in one direction, acquiring cross-sectional OCT images which are then displayed in real time. Line averaging before or after the Fast Fourier Transform (FFT) is available, as well as B-Scan averaging. Image display parameters, such as color mapping, can be controlled in this mode. We have also implemented an option for automatic calculation of the optimum contrast and brightness of the displayed OCT images.

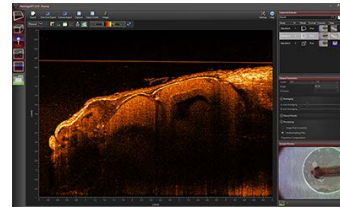

Click to Enlarge
ThorImageOCT Window in the 2D Mode

3D Mode

In the 3D imaging mode, the OCT probe beam scans sequentially across the sample to collect a series of 2D cross-sectional images which are then processed to build a 3D image.

In the ThorImageOCT software, 3D volume datasets can be viewed as orthogonal cross-sectional planes (see below) and volume renderings.

The Sectional View features cross-sectional images in all three orthogonal planes, independent of the orientation in which the data was acquired. The view can be rotated as well as zoomed in and out.

The Rendering View provides a volumetric rendering of the acquired volume dataset. This view enables quick 3D visualization of the sample being imaged. Planes of any orientation can be clipped to expose structures within the volume. The 3D image can be zoomed in and out as well as rotated. Furthermore, the coloring and dynamic range settings can be adjusted.

Utilizing the full potential of our high-performance software in combination with our high-speed OCT systems, we have included a Fast Volume Rendering Mode in the ThorImageOCT software, which serves as a preview for high-resolution 3D acquisitions. In this mode, high-speed volume renderings can be displayed in real-time, providing rapid visualization of samples in three dimensions.

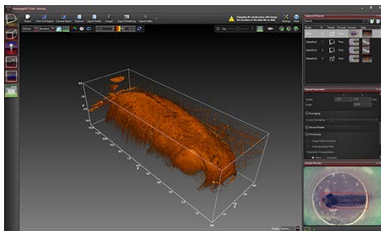

Click to Enlarge
Rendering View of ThorImageOCT

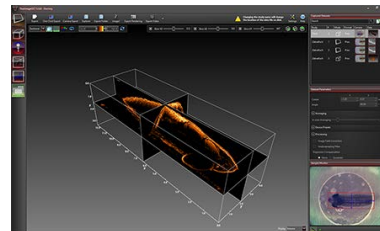

Click to Enlarge
Sectional View of ThorImageOCT

Doppler Mode

Doppler OCT imaging comes standard with all OCT systems. In the Doppler mode, phase shifts between adjacent A-scans are averaged to calculate the Doppler frequency shift induced by particle motion or flow. The number of lateral and axial pixels can be modified to change velocity sensitivity and resolution during phase shift calculation. The Doppler images are displayed in the main window with a color map indicating forward- or backward-directed flow, relative to the OCT beam.

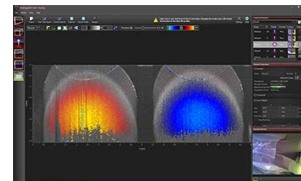

Click to Enlarge
Doppler dataset showing the velocity of a rotated plastic stick with opposite flow directions.

Speckle Variance Mode

The speckle variance imaging mode is an acquisition mode which uses the variance of speckle noise to calculate angiographic images. It can be used to visualize three dimensional vessel trees without requiring significant blood flow and without requiring a specific acquisition speed window. The speckle variance data can be overlaid on top of intensity pictures providing morphological information. Different color maps can be used to display the multimodal pictures.

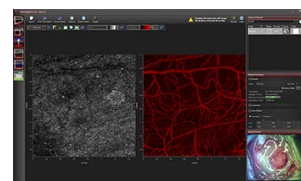

Click to Enlarge

Externally-Triggered Acquisition

ThorImageOCT and the SDK APIs provide the ability to externally trigger the acquisition of A-Scans. This enables the user to synchronize measurements from different modalities (e.g. vibrometry and synchronized positioning) with an OCT measurement. Synchronization is greatly simplified with all current CameraLink-based Thorlabs OCT systems (a TTL level trigger signal source required). External triggering is available for all imaging modes and can be toggled in the settings dialog in ThorImageOCT.

Easy Probe Calibration

Changing to a different scan lens kit will generally require a different probe configuration in order to adapt to changes in the optical parameters of the system. When an additional scan lens is purchased for your Thorlabs OCT scanner system, ThorImageOCT enables you to easily create a fitting configuration for your new scan lens by using the calibration sample shipped with the lens and an intuitive step-by-step calibration process (shown to the right).

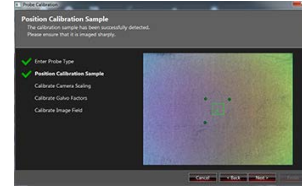

Click to Enlarge
Probe Calibration Window in ThorImageOCT

Video Showing Screencast of ThorImageOCT Rendering Capabilities

In this video, OCT images of a finger are acquired and manipulated in the 3D volume and cross section modes.

OCT TUTORIAL

Optical Coherence Tomography Tutorial

Optical Coherence Tomography (OCT) is a noninvasive optical imaging modality that provides real-time, 1D depth, 2D cross-sectional, and 3D volumetric images with micron-level resolution and millimeters of imaging depth. OCT images consist of structural information from a sample based on light backscattered from different layers of material within the sample. It can provide real-time imaging and is capable of being enhanced using birefringence contrast or functional blood flow imaging with optional extensions to the technology.

Thorlabs has designed a broad range of OCT imaging systems that cover several wavelengths, imaging resolutions, and speeds, while having a compact footprint for easy portability. Also, to increase our ability to provide OCT imaging systems that meet each customer's unique requirements, we have designed a highly modular technology that can be optimized for varying applications.

Application Examples



OCT is the optical analog of ultrasound, with the tradeoff being lower imaging depth for significantly higher resolution (see Figure

1). With up to 15 mm imaging range and better than 5 micrometers in axial resolution, OCT fills a niche between ultrasound and confocal microscopy.

In addition to high resolution and greater imaging depth, the non-contact, noninvasive advantage of OCT makes it well suited for imaging samples such as biological tissue, small animals, and materials. Recent advances in OCT have led to a new class of technologies called Fourier Domain OCT, which has enabled high-speed imaging at rates greater than 700,000 lines per second.¹

Fourier Domain Optical Coherence Tomography (FD-OCT) is based on low-coherence interferometry, which utilizes the coherent properties of a light source to measure optical path length delays in a sample. In OCT, to obtain cross-sectional images with micron-level resolution, and interferometer is set up to measure optical path length differences between light reflected from the sample and reference arms.

There are two types of FD-OCT systems, each characterized by its light source and detection schemes: Spectral Domain OCT (SD-OCT) and Swept Source OCT (SS-OCT). In both types of systems, light is divided into sample and reference arms of an interferometer setup, as illustrated in Fig 2. SS-OCT uses coherent and narrowband light, whereas SD-OCT

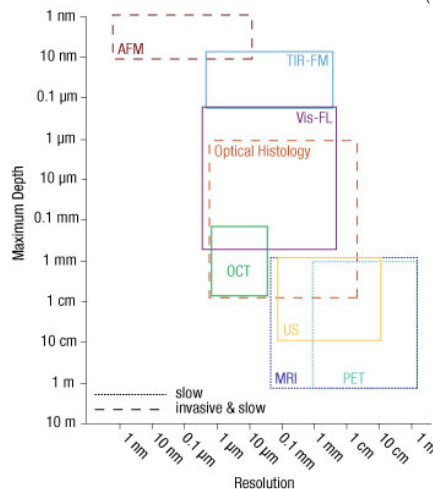

Click to Enlarge

Figure 1

systems utilize broadband, low-coherence light sources. Back scattered light, attributed to variations in the index of refraction within a sample, is recoupled into the sample arm fiber and then combined with the light that has traveled a fixed optical path length along the reference arm. A resulting interferogram is measured through the detection arm of the interferometer.

The frequency of the interferogram measured by the sensor is related to depth locations of the reflectors in the sample. As a result, a depth reflectivity profile (A-scan) is produced by taking a Fourier transform of the detected interferogram. 2D cross-sectional images (B-scans) are produced by scanning the OCT sample beam across the sample. As the sample arm beam is scanned across the sample, a series of A-scans are collected to create the 2D image.

Similarly, when the OCT beam is scanned in a second direction, a series of 2D images are collected to produce a 3D volume data set. With FD-OCT, 2D images are collected on a time scale of milliseconds, and 3D images can be collected at rates now below 1 second.

Spectral Domain OCT vs. Swept Source OCT

Spectral Domain and Swept Source OCT systems are based on the same fundamental principle but incorporate different technical approaches for producing the OCT interferogram. SD-OCT systems have no moving parts and therefore have high mechanical stability and low phase noise. Availability of a broad range of line cameras has also enabled development of SD-OCT systems with varying imaging speeds and sensitivities.

SS-OCT systems utilize a frequency swept light source and photodetector to rapidly generate the same type of interferogram. Due to the rapid sweeping of the swept laser source, high peak powers at each discrete wavelength can be used to illuminate the sample to provide greater sensitivity with little risk of optical damage.

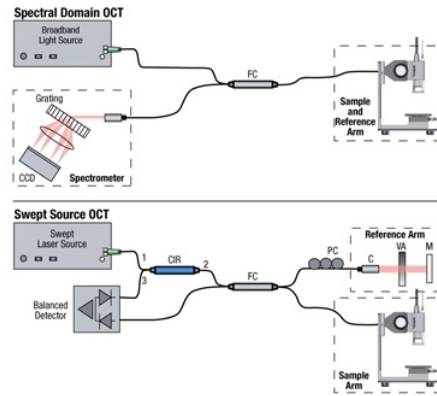

Click to Enlarge
Figure 2

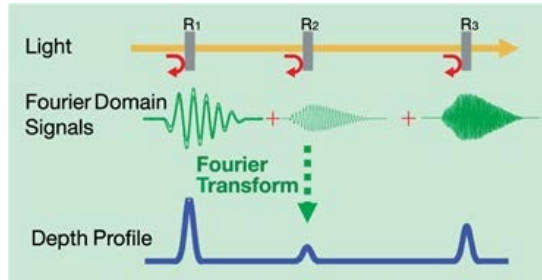

Click to Enlarge

FD-OCT Signal Processing

In Fourier Domain OCT, the interferogram is detected as a function of optical frequency. With a fixed optical delay in the reference arm, light reflected from different sample depths produces interference patterns with the different frequency components. A Fourier transform is used to resolve different depth reflections, thereby generating a depth profile of the sample (A-scan).

¹V. Jayaraman, J. Jiang, H. Li, P. Heim, G. Cole, B. Potsaid, J. Fujimoto, and A. Cable, "OCT Imaging up to 760 kHz Axial Scan Rate Using Single-Mode 1310 nm MEMS-Tunable VCSELs with 100 nm Tuning Range," CLEO 2011 - Laser Applications to Photonic Applications, paper PDPB2 (2011).

BROCHURES

Brochure and Configuration Chart

The buttons below link to PDFs of printable materials and a graphical customization guide for our Telesto Series OCT Systems.



Telesto Series OCT Systems

TELESTO SERIES PRE-CONFIGURED SYSTEMS				
ITEM #	TEL190C1	TEL200C1	TEL200C2	TEL200C3
Center Wavelength	1325 nm	1325 nm	1325 nm	1325 nm
Center Wavelength	1325 nm	1325 nm	1325 nm	1325 nm
Scan Lens Kit	OCT-LK1	OCT-LK2	OCT-LK3	OCT-LK4
Reference Length	OCT-RL1	OCT-RL2	OCT-RL3	OCT-RL4
Accessories	OCT-AT-ND006 and OCT-AT-10156			

TELESTO SERIES OCT BASE UNIT SPECIFICATIONS

ITEM #	TEL210	TEL310	TEL220	TEL320
Center Wavelength	1325 nm	1325 nm	1325 nm	1325 nm
Imaging Depth (Air/Water)	7.0 mm / 5.3 mm	3.5 mm / 2.6 mm	3.5 mm / 2.6 mm	3.5 mm / 2.6 mm
Axial Resolution (Air/Water)	12 µm / 9.0 µm	5.5 µm / 4.2 µm	5.5 µm / 4.2 µm	5.5 µm / 4.2 µm
A-Scan Line Rate	5.5 kHz to 76 kHz	10 kHz to 146 kHz	5.5 kHz to 76 kHz	10 kHz to 146 kHz
Sensitivity	111 dB (at 5.5 kHz) / 109 dB (at 10 kHz)	111 dB (at 5.5 kHz) / 109 dB (at 10 kHz)	111 dB (at 5.5 kHz) / 109 dB (at 10 kHz)	111 dB (at 5.5 kHz) / 109 dB (at 10 kHz)
Eye Safe Class	Class II (at 5.5 kHz) / Class I (at 10 kHz)	Class II (at 5.5 kHz) / Class I (at 10 kHz)	Class II (at 5.5 kHz) / Class I (at 10 kHz)	Class II (at 5.5 kHz) / Class I (at 10 kHz)

Available Base Units:
 • TEL210 High-Speed Imaging
 • TEL310 High-Resolution Imaging
 • TEL220 High-Speed and High-Depth Imaging
 • TEL320 High-Speed and High-Resolution Imaging

THORLABS | www.thorlabs.com

SELECTION GUIDE

Thorlabs offers a variety of OCT Imaging Systems to meet a range of application requirements. The OCT base unit and scan lens kit are key to OCT system performance. Significant performance characteristics, including axial resolution, A-Scan rate, and imaging depth, are entirely or strongly dependent on the design of the OCT base unit. The choice of scan lens kit determines other parameters, such as lateral resolution and field of view. Thorlabs offers a variety of OCT base units and scan lens kits that provide foundations for systems with a wide range of capabilities. The tables below present key performance parameters of our base units and include links to our other OCT imaging system pages. We encourage you to contact us directly at oct@thorlabs.com or via our online request form to discuss specific imaging requirements.

900 nm OCT Base Units

Base Unit Item # ^a	CAL110	GAN210	GAN610	GAN220	GAN620
Series Name (Click for Link)	Callisto	Ganymede			
Key Performance Feature(s)	Laptop PC for Maximum Portability	High Resolution		Very High Resolution	
		General Purpose	High Speed	General Purpose	High Speed
Center Wavelength	930 nm	930 nm		900 nm	
Imaging Depth ^b (Air/Water)	1.7 mm / 1.3 mm	2.9 mm / 2.2 mm	2.7 mm / 2.0 mm	1.9 mm / 1.4 mm	
Axial Resolution ^b (Air/Water)	7.0 µm / 5.3 µm	6.0 µm / 4.5 µm		3.0 µm / 2.2 µm	
A-Scan Line Rate	1.2 kHz	5.5 kHz to 36 kHz	5 kHz to 248 kHz	5.5 kHz to 36 kHz	5 kHz to 248 kHz
Sensitivity (Max) ^c	107 dB	101 dB	102 dB	101 dB	102 dB
OCT Type	Spectral Domain				

- ^a These Item #s are OCT base units that can be customized using a wide selection of OCT scanners, lens kits, and optional accessories.
- ^b Axial resolution and actual imaging depth are dependent on the optical properties of the sample being imaged.
- ^c dB values for the Callisto and Ganymede systems are typical and were measured using a scanner with a common reference/sample path and 50% path split.

1300 nm OCT Base Units

Base Unit Item # ^a	TEL210	TEL310	TEL220	TEL320	TEL210PS	TEL220PS	VEG210	VEG220
Series Name (Click for Link)	Telesto				Telesto PS-OCT		Vega	
Key Performance Feature(s)	High Imaging Depth		High Resolution		High Imaging Depth	High Resolution	Long Imaging Range	
	General Purpose	High Speed	General Purpose	High Speed	Polarization-Sensitive Imaging		General Purpose	High Speed
Center Wavelength	1325 nm		1300 nm		1325 nm	1300 nm	1300 nm	
Imaging Depth ^b (Air/Water)	7.0 mm / 5.3 mm		3.5 mm / 2.6 mm		7.0 mm / 5.3 mm	3.5 mm / 2.6 mm	11 mm / 8.3 mm	8.0 mm / 6.0 mm
Axial Resolution ^b (Air/Water)	12 µm / 9.0 µm		5.5 µm / 4.2 µm		12 µm / 9.0 µm	5.5 µm / 4.2 µm	16 µm / 12 µm	
A-Scan Line Rate	5.5 kHz to 76 kHz	10 kHz to 146 kHz	5.5 kHz to 76 kHz	10 kHz to 146 kHz	5.5 kHz to 76 kHz	5.5 kHz to 76 kHz	100 kHz	200 kHz
Sensitivity (Max) ^c	111 dB	109 dB	111 dB	109 dB	109 dB	109 dB	102 dB	98 dB
OCT Type	Spectral Domain						Swept Source	

- These Item #s are OCT base units that can be customized using a wide selection of OCT scanners, lens kits, and optional accessories.
- Axial resolution and actual imaging depth are dependent on the optical properties of the sample being imaged.
- Values for the Telesto systems are typical and were measured using a scanner with a common reference/sample path and 50% path split. Values measured for the Vega systems are typical and were measured using a scanner with a dual path setup.

Ä

Telesto Series Complete Preconfigured Systems

- ▶ Complete Preconfigured 1300 nm or 1325 nm OCT Systems (See Tables Below)
 - ▶ Item # TEL210C1: Long-Range Imaging
 - ▶ Item # TEL310C1: High-Speed and Long-Range Imaging
 - ▶ Item # TEL220C1: General-Purpose Imaging
 - ▶ Item # TEL320C1: High-Speed and General-Purpose Imaging
- ▶ Fully Customizable Using Other Telesto Series Components

Thorlabs offers four complete, preconfigured Telesto OCT systems, each of which is fully compatible with all Telesto Series OCT components. The TEL210C1 system has a 1325 nm center wavelength and is optimized for imaging deep into the sample. The TEL310C1 doubles the maximum A-Scan rate of the TEL210C1, yielding a maximum of 146 kHz, while matching all of its other performance parameters when operated at equal A-Scan rates (28 kHz and 76 kHz). The TEL220C1 system features a center wavelength of 1300 nm, a maximum A-Scan rate of 76 kHz, and is designed for general purpose imaging applications. The TEL320C1, with a maximum A-Scan rate of 146 kHz, is the high-speed version of the TEL220C1.

These Telesto Series preconfigured OCT system configurations are built completely from components sold in sections located lower on this page. Each preconfigured system includes the three mandatory OCT system core components (the base unit, a scanning system with its reference length adapter, and a scan lens kit), as well as two optional accessories (scanner stand and translation stage). For more information about a component included in the preconfigured systems, click on the component description in the table to the lower left to navigate down to the related section on this page.

For information about these systems or to inquire about custom configurations, please contact oct@thorlabs.com.

Preconfigured System Included Components				
System Item #	TEL210C1	TEL310C1	TEL220C1	TEL320C1
Base Unit	TEL210	TEL310	TEL220	TEL320
Scanning System	OCTG-1300 (Standard Scanner)			
Scan Lens Kit	OCT-LK4		OCT-LK3	
Reference Length Adapter	OCT-RA4		OCT-RA3	
Accessories: Stand and Stage	OCT-STAND(/M) (Scanner Stand) and OCT-XYR1(/M) (Translation Stage)			

- [Click on the component description to navigate down to the related section on this page.](#)

Preconfigured System Key Specifications				
System Item #	TEL210C1	TEL310C1	TEL220C1	TEL320C1
Imaging Depth (Air/Water)	7.0 mm / 5.3 mm		3.5 mm / 2.6 mm	
Axial Resolution (Air/Water)	12 μ m / 9.0 μ m		5.5 μ m / 4.2 μ m	
Lateral Resolution	20 μ m		13 μ m	
A-Scan/Line Rate	5.5 - 76 kHz ^a	10 - 146 kHz ^b	5.5 - 76 kHz ^a	10 - 146 kHz ^b
Sensitivity (Max)	111 dB (at 5.5 kHz)	109 dB (at 10 kHz)	111 dB (at 5.5 kHz)	109 dB (at 10 kHz)

- [Four Discrete A-Scan Rates: 5.5 kHz, 28 kHz, 48 kHz, and 76 kHz](#)
- [Four Discrete A-Scan Rates: 10 kHz, 28 kHz, 76 kHz, and 146 kHz](#)

Part Number	Description	Price	Availability
TEL210C1	Spectral Domain OCT System, 1325 nm, 12 μ m Resolution, 5.5 to 76 kHz	\$70,019.40	Lead Time
TEL220C1	Spectral Domain OCT System, 1300 nm, 5.5 μ m Resolution, 5.5 to 76 kHz	\$74,263.00	Lead Time
TEL310C1	Spectral Domain OCT System, 1325 nm, 12 μ m Resolution, 10 to 146 kHz	\$80,628.40	Lead Time
TEL320C1	Spectral Domain OCT System, 1300 nm, 5.5 μ m Resolution, 10 to 146 kHz	\$84,872.00	Lead Time

Ä

OCT Base Units (Required OCT System Component)

- ▶ 1300 nm or 1325 nm Center Wavelength Options
 - ▶ 1300 nm, High Resolution: 3.5 mm Imaging Depth and 5.5 μ m Resolution in Air
 - ▶ 1325 nm, Long Range: 7 mm Imaging Depth and 12 μ m Resolution in Air
- ▶ Each Base Unit has Four A-Scan Rates for Flexibility in Imaging Speed and Sensitivity
 - ▶ 5.5 kHz to 76 kHz A-Scan Rate; 111 dB Max Sensitivity
 - ▶ 10 kHz to 146 kHz A-Scan Rate; 109 dB Max Sensitivity

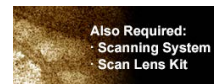

To be functional, an OCT system build must include a base unit, a scanning system, and a scan lens kit.

The imaging performance of any OCT system is largely dependent on the design and components incorporated into the base unit. All of Thorlabs' OCT Base Units include an OCT engine, high-performance computer, pre-installed software, and a software development kit (SDK). For the Telesto OCT Base Units, the engine is comprised of a superluminescent diode light source, scanning electronics, and a linear InGaAs array-based spectrometer for detection. The engine and detection components are integrated into a 420 mm x 320 mm x 149 mm (16.55" x 12.61" x 5.88") housing. For a fully operational system, one scanning system and a scan

lens kit (both sold separately below) must be purchased along with a base unit.

Deep-Imaging Base Units

Thorlabs TEL210 and TEL310 Deep-Imaging Base Units are designed using an SLD1325 superluminescent diode that provides over 100 nm of spectral bandwidth and enables the base units to achieve a very high 7.0 mm imaging depth with 12 µm of axial imaging resolution. For these reasons, this base unit is the ideal choice for long-range imaging of highly-scattering samples in an air medium. Two base units at this wavelength are available. The TEL310 is capable of operating at A-Scan rates up to 146 kHz, which is twice as fast as the TEL210. At equal A-Scan rates (28 kHz and 76 kHz), the two perform equally well. As the TEL210 offers a lower A-Scan rate option than the TEL310, it provides a higher sensitivity: 111 dB sensitivity at 5.5 kHz for the TEL210 compared with 109 dB at 10 kHz for the TEL310.

High-Resolution Base Units

Our TEL220 and TEL320 High-Resolution Base Units feature Thorlabs' highest resolution OCT imaging capability at 1300 nm. An ideal choice for high-resolution imaging in scattering samples, these base units utilize Thorlabs' unique matched-pair superluminescent diodes for over 170 nm of bandwidth that translates to 5.5 µm axial resolution at an imaging depth of 3.5 mm. Two base units at this wavelength are available. The TEL320 is capable of operating at A-Scan rates up to 146 kHz, which is twice as fast as the TEL220. At equal A-Scan rates (28 kHz and 76 kHz), the two perform equally well. As the TEL220 offers a lower A-Scan rate option than the TEL320, it provides a higher sensitivity: 111 dB sensitivity at 5.5 kHz for the TEL220 compared with 109 dB at 10 kHz for the TEL320.

Base Unit Item #	TEL210	TEL310	TEL220	TEL320
Description	Long-Range Imaging		High-Resolution Imaging	
Center Wavelength	1325 nm		1300 nm	
Imaging Depth (Air/Water)	7.0 mm / 5.3 mm		3.5 mm / 2.6 mm	
Axial Resolution (Air/Water)	12 µm / 9.0 µm		5.5 µm / 4.2 µm	
A-Scan Line Rate	5.5, 28, 48, & 76 kHz	10, 28, 76, & 146 kHz	5.5, 28, 48, & 76 kHz	10, 28, 76, & 146 kHz
Sensitivity ^a	96 dB (at 76 kHz) to 111 dB (at 5.5 kHz)	93 dB (at 146 kHz) to 109 dB (at 10 kHz)	96 dB (at 76 kHz) to 111 dB (at 5.5 kHz)	93 dB (at 146 kHz) to 109 dB (at 10 kHz)
Maximum Pixels per A-Scan	1024			
Compatible Scanners	OCTP-1300, OCTP-1300/M, OCTG-1300, and OCTH-1300			

- ^aTypical Values Measured Using a Scanner with a Common Reference/Sample Path and 50% Path Split

Computer Specifications ^a	
Operating System	Windows 10, 64 Bit
Processor	Quad Core, 3.6 GHz
Memory	32 GB
Hard Drive	512 GB SSD
Data Acquisition	Camera Link

- ^aComputer Specifications Subject to Change

Part Number	Description	Price	Availability
TEL210	Telesto OCT Base Unit, 1325 nm, 12 µm Resolution, 5.5 to 76 kHz	\$53,045.00	Lead Time
TEL220	Telesto OCT Base Unit, 1300 nm, 5.5 µm Resolution, 5.5 to 76 kHz	\$57,288.60	Lead Time
TEL310	Telesto OCT Base Unit, 1325 nm, 12 µm Resolution, 10 to 146 kHz	\$63,654.00	Lead Time
TEL320	Telesto OCT Base Unit, 1300 nm, 5.5 µm Resolution, 10 to 146 kHz	\$67,897.60	Lead Time

Ä

Scanning Systems (Required OCT System Component)

- ▶ Scan an OCT Light Source Beam Across a Sample to Acquire 2D or 3D Images
- ▶ Three Available Options
 - ▶ Standard Scanner for High Stability and Ease-of-Use
 - ▶ User-Customizable Scanners with Open Construction for Customization of Scan Path
 - ▶ Portable Handheld Scanner for Applications Requiring High Mobility



OCTG-1300
Click to Enlarge Standard OCT Scanner



OCTP-1300
Click to Enlarge User-Customizable OCT Scanner



OCTH-1300
Click to Enlarge Handheld OCT Scanner

Thorlabs' OCT Scanning Systems are designed to scan the OCT light source beam across a sample for 2D cross-sectional and 3D volumetric imaging. OCT applications can vary widely, from live animal imaging to industrial materials analysis, with each requiring a different set of scanning parameters. We currently offer three types of beam scanning systems for use with our Telesto Base Units: standard, user-customizable, and handheld.

Each scanner contains an OCT interferometer with a sample arm and a reference arm. The reference arm of the OCT interferometer is placed near the sample and housed within the scanning system itself to guarantee the phase stability of the sample arm relative to the reference arm. To account for different sample distances and reflectivities (e.g., while imaging through water), the reference arm path length, as well as the reference arm intensity, is user-adjustable. To minimize image distortion caused by dispersion, our OCT systems are designed to optically match the reference and sample arm lengths to the greatest extent possible. Dispersion effects from the sample (e.g., imaging through water or glass) can be compensated for using the included ThorImage OCT software. For customers interested in dual-path setups, any of these scanners can be configured without a beamsplitter; please contact oct@thorlabs.com for more information.

Scanner Type	Item #	Compatible Base Units
Standard Scanner ^a	OCTG-1300	TEL210
User-Customizable Scanner	OCTP-1300(M)	TEL220 TEL310
Handheld Scanner ^b	OCTH-1300	TEL320

- ^aStandard Scanner Requires Purchase of Reference Length Adapter
- ^bSample Z-Spacers Recommended When Using OCTH-1300

All scanners are equipped with an integrated camera that can obtain real-time *en face* video of the sample during OCT measurements when used with our ThorImage OCT software (see the *Software* tab for details). Illumination of the sample is provided by a ring of user-adjustable white light LEDs around the exit aperture of each scanner.

Standard Scanner

The OCTG-1300 Standard Scanner is ideal for imaging applications that require a stable, easy-to-operate setup. The entire design of the standard scanner is contained within a rugged, light-tight housing that minimizes the risk of misalignment. The standard scanner is equipped with a reference path length distance indicator for ease-of-use during reference adjustments. A knob located at the top of the standard scanner allows for fine adjustments to the reference path length.

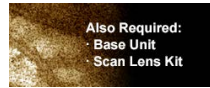

To be functional, an OCT system build must include a base unit, a scanning system, and a scan lens kit.



Click to Enlarge OCTH-1300 Handheld Scanner with OCTH-AIR30 Sample Z-Spacer

User-Customizable Scanner

The OCTP-1300(M) User-Customizable Scanner is designed with an open construction to enable easy customization of the optical beam path using Thorlabs' standard optomechanical components. This scanner features SM1 (1.035"-40) ports and 4-40 tapped holes at several locations that allow mounting of SM1-threaded or 30 mm cage-compatible components, respectively. The scan lens port is directly compatible with either M25 x 0.75 or SM1-threaded components, and can be converted to other thread standards, such as RMS (0.800"-36) via our selection of thread adapters. Additional scanning and non-scanning optical input/output ports are available for integration of a laser for fluorescence excitation or additional sample illumination.

Compact Handheld Scanner

The compact and lightweight OCTH-1300 Handheld Scanner is specifically designed for applications requiring high mobility. Easy access buttons located directly on the scanner enable fingertip control of our ThorImage OCT Software. Users can program each button from a selection of imaging and acquisition software controls and the software uses visual and audio feedback for button presses. The OCTH-1300 features a removable cover under the handle that provides access to the reference length and intensity settings. Compatible scan lens kits and sample z-spacers for the OCTH-1300 are sold below; z-spacers help maintain the correct working distance when using the handheld scanner. Please note that due to the limitations of the internal MEMS scanner, the frame rate (i.e., B-Scan rate) is limited to 25 frames per second when using the handheld scanner.

Part Number	Description	Price	Availability
OCTP-1300/M	Customer Inspired! User-Customizable Scanner for 1300 nm & 1325 nm SD-OCT Systems, Metric	\$12,730.80	Lead Time
OCTG-1300	Standard Scanner for 1300 nm & 1325 nm SD-OCT Systems	\$12,200.35	Lead Time
OCTH-1300	Handheld Scanner for 1300 nm & 1325 nm SD-OCT Systems	\$10,502.91	Lead Time
OCTP-1300	Customer Inspired! User-Customizable Scanner for 1300 nm & 1325 nm SD-OCT Systems, Imperial	\$12,730.80	Lead Time

A

Scan Lens Kits (Required OCT System Component)

- ▶ Telecentric Scan Lenses Provide a Flat Imaging Plane
- ▶ Lens AR Coated for 1315 ± 65 nm
- ▶ Scan Lens Kits for Standard / User-Customizable Scanners Include
 - ▶ Telecentric Scan Lens
 - ▶ Illumination Tube
 - ▶ IR Card
 - ▶ Calibration Target
- ▶ Compact Scan Lens Kits Designed for the OCTH-1300 Handheld Scanner with Integrated Scan Lens and Illumination Ring

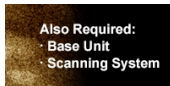

To be functional, an OCT system build must include a base unit, a scanning system, and a scan lens kit.

The cross sectional images of a finger pad, shown below, were taken with a Teleso Series OCT system fitted with the OCT-LK2 (left) and OCT-LK4 (right) scan lens kits. The selection of available Teleso series components offer significant flexibility in building an OCT system optimized for your application.

OCT-LK2 High Resolution



Click to Enlarge Magnification: 10X Scan Region: 6 mm x 3.5 mm Lateral Resolution: 7 μm

OCT-LK4 Deep Imaging



Click to Enlarge Magnification: 3X Scan Region: 16 mm x 3.5 mm Lateral Resolution: 20 μm

Thorlabs' Scan Lens Kits enable easy exchange of scan lenses in an OCT system, providing the flexibility to tailor imaging resolution or working distance for each application. Based on our line of OCT telecentric scan lenses, these lens kits minimize image distortion without extensive post-image processing and maximize coupling of the light scattered or emitted from the sample surface into the detection system. As seen in the table below, we offer scan lens kits compatible with the standard (Item # OCTG-1300) and user-customizable (Item # OCTP-1300) scanners, as well as two lens kits compatible with the handheld scanner (Item # OCTH-1300).

Each kit includes a telecentric scan lens, illumination tube, IR card, and calibration target. The included illumination tube serves as a light guide that channels light from the LED illumination ring down to the sample area. The IR card and calibration target are provided for calibration of the scanning mirror and lens kit, ensuring the best image quality when swapping between scan lenses.

Item #	OCT-LK2	OCT-LK3	OCT-LK4	OCTH-LK20	OCTH-LK30
Click Image to Enlarge					
Design Wavelength	1300 nm / 1325 nm			1300 nm / 1325 nm	
Compatible Scanner	OCTG-1300 (Standard) or OCTP-1300 (User-Customizable)			OCTH-1300 Handheld Scanner	
Lateral Resolution ^a	7 μm	13 μm	20 μm	16.0 μm	24.0 μm
Focal Length	18 mm	36 mm	54 mm	20 mm	30 mm
Working Distance	3.4 mm (with Tube) ^b 7.5 mm (without Tube)	24.9 mm (with Tube) ^b 25.1 mm (without Tube)	41.6 mm (with Tube) ^b 42.3 mm (without Tube)	12 mm	22 mm

Field of View	6 mm x 6 mm	10 mm x 10 mm	16 mm x 16 mm	Ø8 mm	Ø10 mm
Lens Threading	M25 x 0.75	M25 x 0.75	M25 x 0.75	M20 x 0.5 (For Z-Spacer) M14 x 0.5 (For OCTH-1300)	

- $\lambda/4$ Beam Diameter at Focus
- The illumination tube is user-removable.

Part Number	Description	Price	Availability
OCT-LK2	OCT Scan Lens Kit, 18 mm FL, 1300 nm / 1325 nm	\$2,056.02	Lead Time
OCT-LK3	OCT Scan Lens Kit, 36 mm FL, 1300 nm / 1325 nm	\$1,406.75	Lead Time
OCT-LK4	OCT Scan Lens Kit, 54 mm FL, 1300 nm / 1325 nm	\$1,406.75	Lead Time
OCTH-LK20	OCT Scan Lens Kit for OCTH-1300, 20 mm FL	\$1,071.29	Lead Time
OCTH-LK30	OCT Scan Lens Kit for OCTH-1300, 30 mm FL	\$1,071.29	Lead Time

Á

Reference Length Adapters (Required for Standard Scanners)

- ▶ Arm Adapters for Matching Reference Path Length to the Sample Path Length
- ▶ Use Multiple Reference Adapters for Rapid Switching Between Scan Lens Kits
- ▶ Must be Purchased with Standard Scanner (Item # OCTG-1300)

Item # ^a	Compatible Scan Lens Kit
OCT-RA2	OCT-LK2
OCT-RA3	OCT-LK3
OCT-RA4	OCT-LK4

These adapters adjust the reference arm path length within the OCTG-1300 Standard Scanner to match the sample path length of the scan lens used. Choose from three options that are compatible with the scan lens kits sold above. Reference length adapters also enable the user to quickly swap between different scan lens kits without going through extensive adjustments during each switch. The table to the right provides a compatibility list to help select the appropriate reference adapters.

- $\lambda/4$ Multiple reference adapters can be purchased for rapid switching between scan lens kits.

Part Number	Description	Price	Availability
OCT-RA2	Length Adapter for SD-OCT Standard Scanner & OCT-LK2(-BB) Scan Lens Kit	\$551.88	Lead Time
OCT-RA3	Length Adapter for SD-OCT Standard Scanner & OCT-LK3(-BB) Scan Lens Kit	\$551.88	Lead Time
OCT-RA4	Length Adapter for SD-OCT Standard Scanner & OCT-LK4(-BB) Scan Lens Kit	\$551.88	Lead Time

Á

Sample Z-Spacers (Optional Accessories)



Click to Enlarge Z-Spacers for the OCTG-1300 and OCTP-1300(M) Scanners

- ▶ Sample Z-Spacers Position Scanner at Optimal Working Distance From Sample
- ▶ Ring (Air) and Immersion (Liquid) Z-Spacers Available
- ▶ Two Z-Spacers Recommended for Use with OCTH-1300 Handheld Scanner

Thorlabs offers both ring and immersion style sample Z-spacers that enable optimal positioning of a scanning system relative to the sample. The OCT-AIR3, OCT-IMM3, and OCT-IMM4 Z-Spacers feature knurled rings that allow the spacing distance to be adjusted and locked in place for increased stability. Several Z-spacer options are available; please see the table below for compatibility with our scanners and lens kits.



Click to Enlarge Z-Spacers for the OCTH-1300 Handheld Scanner

Additionally, we offer two ring-style z-spacers that are designed specifically for the OCTH-1300 Handheld Scanner; these spacers greatly assist in maintaining the correct sample working distance when using the handheld scanner. The spacing distance on the OCTH-AIR20 and OCTH-AIR30 Z-Spacers can be adjusted by rotating the spacer.

Our ring-style Z-spacers provide a distance guide between the scanner and sample. The sample is in contact with the ring-shaped tip of the spacer and should only be used when air is the scanning medium. In contrast, our immersion spacers are equipped with a glass plate that contacts the sample surface within the scanning area. Unlike the ring-style spacers, immersion spacers enable access to samples contained within a liquid environment while also providing sample stabilization. Better index matching and a tilted glass plate also help reduce strong back reflections from the sample surface and enhances the contrast of the image.

Item # ^a	Type	Adjustable	Adjustment Range	Lockable	Compatible Scanner	Compatible Scan Lens Kit
OCT-AIR3	Ring (Air)	Yes	+3.5 mm / -1.0 mm	Yes	OCTG-1300 OCTP-1300(M)	OCT-LK3
OCT-IMM3	Immersion	Yes	+3.4 mm / -1.1 mm	Yes		OCT-LK4
OCT-IMM4	Immersion	Yes	+1.0 mm / -17.0 mm	Yes		
OCTH-AIR20	Ring (Air)	Yes	±4 mm	No	OCTH-1300 ^a	OCTH-LK20
OCTH-AIR30	Ring (Air)	Yes	±2 mm	No		OCTH-LK30

- $\lambda/4$ We recommend purchasing a sample Z-spacer if using the OCTH-1300 handheld scanner.

Part Number	Description	Price	Availability
OCT-AIR3	Ring-Style Sample Z-Spacer for OCT-LK3(-BB) Scan Lens Kit	\$772.63	Lead Time
OCT-IMM3	Immersion-Style Sample Z-Spacer for OCT-LK3(-BB) Scan Lens Kit	\$938.20	Lead Time
OCT-IMM4	Immersion-Style Sample Z-Spacer for OCT-LK4(-BB) Scan Lens Kit	\$1,048.57	Lead Time

OCTH-AIR20	Ring-Style Sample Z-Spacer for OCTH-LK20(-BB) Scan Lens Kit	\$199.11	Lead Time
OCTH-AIR30	Ring-Style Sample Z-Spacer for OCTH-LK30(-BB) Scan Lens Kit	\$199.11	Lead Time

A

Scanner Stand (Optional Accessory)

- ▶ Recommended Stand for Mounting Standard or User-Customizable Scanners
- ▶ Focus Block with Coarse/Fine Z-Axis Travel on Ø1.5" Stainless Steel Post
- ▶ 12" x 14" (300 mm x 350 mm) Aluminum Breadboard with 1/4"-20 (M6) Tapped Holes

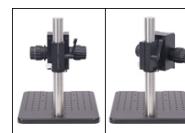

Click for Details
The focus block can be rotated 45° to move the scanner head away from the sample.

For convenient mounting of our Standard or User-Customizable Scanners, we offer a scanner stand that is ideal for use in vibration-sensitive studies such as angiography. It consists of a post-mounted focus block with knobs that provide both coarse (40 mm/rev) and fine (225 µm/rev) z-axis travel. A rotation and height collar underneath the focus block allows it to rotate 45° in order to move the scanner head away from the sample to make adjustments.

The focus block attaches to a 12" x 14" (300 mm x 350 mm) aluminum breadboard via the included Ø1.5" post. The aluminum breadboard has side grips and rubber feet for easy lifting and transportation. There is an array of 1/4"-20 (M6) tapped holes for mounting optomechanics. Four extra 1/4"-20 (M6) tapped holes allow the mounting of the OCT-XYR1 Translation Stage (sold below) to the OCT-STAND and the OCT-XYR1/M Translation Stage to the OCT-STAND/M directly underneath the scan lens. A 1/4"-20 (M6) counterbore is also provided for securing the Ø1.5" post.

Part Number	Description	Price	Availability
OCT-STAND/M	Stand for Standard and User-Customizable OCT Scanning Systems, M6 Tapped Holes	\$2,164.24	5-8 Days
OCT-STAND	Stand for Standard and User-Customizable OCT Scanning Systems, 1/4"-20 Tapped Holes	\$2,164.24	Lead Time

A

Translation Stage (Optional Accessory)

- ▶ Optional Translation Stage with 0.5" (13 mm) of XY Travel and 360° Rotation
- ▶ Includes Cover Plate for Sample Mounting
- ▶ Can Mount Optomechanics by Removing Cover Plate

Specifications	
Horizontal Load Capacity (Max)	10 lbs (4.5 kg)
Mounting Platform Dimensions	Ø4.18" (Ø106 mm)
Stage Height	1.65" (41.8 mm)
Linear Translation Range	1/2" (13 mm)
Travel per Revolution	0.025" (0.5 mm)
Graduation	0.001" (10 µm) per Division



Click to Enlarge
The cover plate is removable for access to tapped holes and the SM1-threaded central hole.

Precise translation and rotation are often required for optimal positioning of a sample before and during OCT imaging. The OCT-XYR1(M) is an XY linear translation stage with a rotating platform and solid plate for sample mounting and easy cleaning. The OCT-XYR1 or OCT-XYR1/M stage can be secured to the OCT-STAND or OCT-STAND/M, respectively, using the 1/4" (M6) counterbores at the corners. The top plate is removable for access to 4-40, 8-32 (M4), and 1/4"-20 (M6) tapped holes and an SM1-threaded (1.035"-40) central hole for mounting optomechanical components. The XYR1A Solid Sample Plate can be purchased separately as a direct replacement for the top plate.

The X and Y micrometers offer 1/2" (13 mm) of travel with graduations every 0.001" (10 µm). The stage's rotation and translation can be freely changed without compromising the stability of attached components. An engraved angular scale along the outer edge of the stage's rotating platform allows the user to set the angular orientation of the stage, which can then be fixed using the 5/64" (2 mm) hex locking setscrew. Locking the rotation of the stage does not prevent XY translation using the actuators.

Part Number	Description	Price	Availability
OCT-XYR1/M	XY Stage with Solid Top Plate, 13 mm Travel, 360° Rotation, Metric Taps	\$772.63	Today
OCT-XYR1	XY Stage with Solid Top Plate, 1/2" Travel, 360° Rotation, Imperial Taps	\$772.63	5-8 Days

