

PDF10A/M - March 4, 2020

Item # PDF10A/M was discontinued on March 4, 2020. For informational purposes, this is a copy of the website content at that time and is valid only for the stated product.

SI FREE-SPACE AMPLIFIED PHOTODETECTORS

- ▶ **Wavelength Ranges from 200 nm to 1100 nm**
- ▶ **Maximum Bandwidths up to 1.5 GHz**
- ▶ **Sensitivities Down to Femtowatt Powers**
- ▶ **Fixed and Switchable Gain Versions**

Application Idea

PDA Series Detector with Ø1" Lens Tube
Attached to a 30 mm Cage System



PDA10A2
Fixed Gain
150 MHz Max Bandwidth



PDA36A2
Switchable Gain
12 MHz Max Bandwidth



FPD610-FS-VIS
Fixed Gain
600 MHz Max Bandwidth

[Hide Overview](#)

OVERVIEW**Features**

- Wavelength Ranges within 200 to 1100 nm
- Low-Noise Amplification with Fixed or Switchable Gain
- Load Impedances 50 Ω and Higher for ≥3 kHz Bandwidth Versions
- Free-Space Optical Coupling

We offer a selection of Silicon (Si) Free-Space Amplified Photodetectors that are sensitive to light in the UV to the NIR wavelength range. Thorlabs' amplified photodetectors feature a built-in low-noise transimpedance amplifier (TIA) or a low-noise TIA followed by a voltage amplifier. Menlo Systems' FPD series amplified photodetectors have a built-in radio frequency (RF) or transimpedance amplifier. We offer fixed-gain versions that possess a fixed maximum bandwidth and total transimpedance gain, as well as switchable-gain versions with two or eight gain settings.

Thorlabs' photodetectors are designed to meet a range of requirements, with offerings that include the 380 MHz PDA015A with an impulse response of 1 ns, the high-sensitivity PDF10A with a noise equivalent power (NEP) of 1.4 fW/Hz^{1/2}, and the switchable-gain PDA100A2 with eight switchable maximum gain (bandwidth) combinations from 1.51 kV/A (11 MHz) to 4.75 MV/A (3 kHz). The PDF10A with femtowatt sensitivity is a low-frequency device that should only be terminated into high impedance (Hi-Z) loads, while all other of our silicon amplified photodetectors are capable of driving loads from 50 Ω to Hi-Z.

Item #	Wavelength Range	Bandwidth	NEP
Fixed Gain			
PDA10A2	200 - 1100 nm	DC - 150 MHz	29.2 pW/Hz ^{1/2}
PDA8A2	320 - 1000 nm	DC - 50 MHz	7.8 pW/Hz ^{1/2}
PDF10A(/M)	320 - 1100 nm	DC - 20 Hz	1.4 x 10 ⁻³ pW/Hz ^{1/2}
PDA015A(/M)	400 - 1000 nm	DC - 380 MHz	36 pW/Hz ^{1/2}
FPD510-FS-VIS	400 - 1000 nm	DC - 250 MHz	6.0 pW/Hz ^{1/2}
FPD610-FS-VIS	400 - 1000 nm	DC - 600 MHz	11.2 pW/Hz ^{1/2}
Switchable Gain			
PDA100A2 ^a	320 - 1100 nm	DC - 11 MHz	2.67 - 71.7 pW/Hz ^{1/2}
PDA36A2 ^a	350 - 1100 nm	DC - 12 MHz	3.25 - 75.7 pW/Hz ^{1/2}
FPD310-FS-VIS ^b	400 - 1000 nm	1 - 1500 MHz	24.0 pW/Hz ^{1/2}

- Switchable with 8 x 10 dB steps.
- Switchable with 2 steps, 0 and 20 dB.

Every detector has internal SM05 (0.535"-40) threading and external SM1 (1.035"-40) threading. Except for some select detectors, each unit's housing features 8-32 tapped holes (M4 for -EC and /M models). The PDA10A2, PDA8A2, PDA36A2,



Click to Enlarge
The PDA10A2 with the
Included ± 12 V Power Supply.
Replacement power supplies
are sold below.

and PDA100A2 feature a new housing with universal taps that accept both 8-32 and M4. For more information about the location of these mounting points and mounting these units, please see the *Housing Features* and *Mounting Options* tabs.

Menlo Systems' FPD series detectors are easy-to-use photodiode packages with an integrated high-gain, low-noise RF (FPD310-FS-VIS) or transimpedance (FPD510-FS-VIS and FPD610-FS-VIS) amplifier. The FPD310-FS-VIS is ideal for experiments requiring high bandwidths and extremely short rise times (<1 ns). This detector has a switchable gain with two steps, 0 and 20 dB. The FPD510-FS-VIS and FPD610-FS-VIS have a fixed gain and are optimized for the highest signal-to-noise ratio when detecting low-level optical beat signals at frequencies up to 250 MHz and 600 MHz, respectively. The FPD510-FS-VIS has a rise time of 2 ns, while the FPD610-FS-VIS has a 1 ns rise time. The 3 dB bandwidth of these DC-coupled devices is 200 MHz for the FPD510-FS-VIS and 500 MHz for the FPD610-FS-VIS. The compact design of the FPD detectors allows for easy OEM integration. The housing of each Menlo detector features one M4 tapped hole for post

mounting. For more information about the housing, please see the *Housing Features* tab. For versions of these detectors with FC/PC inputs, see Si Fiber-Coupled Amplified Detectors.

Power Supply

A ± 12 V linear power supply that supports input voltages of 100, 120, and 230 VAC is included with each amplified photodetector. Replacement power supplies are available separately below. Before connecting the power supply to the mains, ensure that the line voltage switch on the power supply module is set to the proper voltage range. The power supplies should always be powered up using the power switch on the power supply itself. Hot plugging the unit is not recommended.

Menlo's FPD510-FS-VIS, FPD610-FS-VIS, and FPD310-FS-VIS include a low-noise power supply.



Click to Enlarge
Menlo Systems' Detectors
Include a Location-
Specific ± 12 V Power
Supply

[Hide Specs](#)

S P E C S

Performance Specifications

Item #	Wavelength	Bandwidth	Rise Time	Peak Responsivity	Noise Equivalent Power (NEP) ^a	Active Area	Operating Temperature Range
Fixed Gain							
PDA10A2 ^b	200 - 1100 nm ^c	DC - 150 MHz	2.3 ns	0.44 A/W @ 730 nm	29.2 pW/Hz ^{1/2}	0.8 mm ² ($\varnothing 1$ mm)	10 to 50 °C
PDA8A2	320 - 1000 nm	DC - 50 MHz	7 ns	0.56 A/W @ 820 nm	7.8 pW/Hz ^{1/2}	0.5 mm ² ($\varnothing 0.8$ mm)	10 to 50 °C
PDF10A	320 - 1100 nm	DC - 20 Hz	22 ms	0.6 A/W @ 960 nm	1.4×10^{-3} pW/Hz ^{1/2}	1.2 mm ² (1.1 mm x 1.1 mm)	18 to 28 °C
PDA015A ^b	400 - 1000 nm	DC - 380 MHz	1.0 ns	0.47 A/W @ 740 nm	36 pW/Hz ^{1/2}	0.018 mm ² ($\varnothing 150$ μ m)	10 to 40 °C
FPD510-FS-VIS	400 - 1000 nm	DC - 250 MHz	2 ns	-	6.0 pW/Hz ^{1/2}	0.13 mm ² ($\varnothing 0.4$ mm)	10 to 40 °C
FPD610-FS-VIS	400 - 1000 nm	DC - 600 MHz	1 ns	-	11.2 pW/Hz ^{1/2}	0.13 mm ² ($\varnothing 0.4$ mm)	10 to 40 °C
Switchable Gain							
PDA100A2 ^b	320 - 1100 nm	DC - 11 MHz ^d	N/A ^e	0.72 A/W @ 960 nm	2.67 - 71.7 pW/Hz ^{1/2}	75.4 mm ² ($\varnothing 9.8$ mm)	10 to 40 °C
PDA36A2 ^b	350 - 1100 nm	DC - 12 MHz ^d	N/A ^e	0.65 A/W @ 970 nm	3.25 - 75.7 pW/Hz ^{1/2}	13 mm ² (3.6 mm x 3.6 mm)	10 to 40 °C
FPD310-FS-VIS	400 - 1000 nm	1 - 1500 MHz	0.5 ns	-	24.0 pW/Hz ^{1/2}	0.13 mm ² ($\varnothing 0.4$ mm)	10 to 40 °C

- NEP is specified at the peak responsivity wavelength. As NEP changes with the gain setting for the switchable-gain versions, an NEP range is given for these.
- This detector has a 50 Ω terminator resistor that is in series with the amplifier output. This forms a voltage divider with any load impedance (e.g. 50 Ω load divides signal in half).
- When long-term UV light is applied, the product specifications may degrade. For example, the product's UV response may decrease and the dark current may increase. The degree to which the specifications may degrade is based upon factors such as the irradiation level, intensity, and usage time.
- This is the maximum possible bandwidth for these amplified photodetectors. Bandwidth varies as a function of gain. For more information see the *Switchable Gain* table below.

- Rise times depend on the chosen gain level and wavelength. As one increases the gain of a given optical amplifier, the bandwidth is reduced, and hence, the rise time increases. Please refer to the photodiode tutorial for information on calculating the rise time. Bandwidth specifications for each switchable photodetector may be found in the table below.

Gain Specifications

Fixed Gain

Item #	Gain w/ Hi-Z Load	Gain w/ 50 Ω Load	Offset (\pm)	Output Voltage w/ Hi-Z Load	Output Voltage w/ 50 Ω Load
PDA10A2	10 kV/A	5 kV/A	10 mV	0 - 10 V	0 - 5 V
PDA8A2	100 kV/A	50 kV/A	± 10 mV (Max)	0 - 3.6 V	0 - 1.8 V
PDF10A ^a	1×10^9 kV/A	-	<150 mV	0 - 10 V	-
PDA015A	50 kV/A	25 kV/A	20 mV	0 - 10 V	0 - 5 V
FPD510-FS-VIS	-	1.5×10^5 V/W	-	-	0 - 1 V
FPD610-FS-VIS	-	2×10^6 V/W	-	-	0 - 1 V

- Due to its 25 Hz cutoff frequency, operating the PDF10A(M) with less than high impedance loading is not recommended.

Switchable Gain

Item #	Gain Step (dB)	Gain w/ Hi-Z Load ^a	Gain w/ 50 Ω Load ^a	Bandwidth	Noise (RMS)	NEP ^b	Offset (\pm)	Output Voltage w/ Hi-Z Load	Output Voltage w/ 50 Ω Load
PDA100A2	0	1.51 kV/A	0.75 kV/A	11 MHz	268 μ V	71.7 pW/Hz ^{1/2}	5 mV (10 mV Max)	0 - 10 V	0 - 5 V
	10	4.75 kV/A	2.38 kV/A	1.4 MHz	195 μ V	6.75 pW/Hz ^{1/2}	6 mV (10 mV Max)		
	20	15 kV/A	7.5 kV/A	800 kHz	219 μ V	3.36 pW/Hz ^{1/2}	6 mV (10 mV Max)		
	30	47.5 kV/A	23.8 kV/A	260 kHz	222 μ V	2.83 pW/Hz ^{1/2}	6 mV (10 mV Max)		
	40	151 kV/A	75 kV/A	90 kHz	229 μ V	2.67 pW/Hz ^{1/2}	6 mV (10 mV Max)		
	50	475 kV/A	238 kV/A	28 kHz	271 μ V	4.2 pW/Hz ^{1/2}	6 mV (10 mV Max)		
	60	1.5 MV/A	750 kV/A	9 kHz	423 μ V	6.24 pW/Hz ^{1/2}	6 mV (10 mV Max)		
	70	4.75 MV/A	2.38 MV/A	3 kHz	1.22 mV	7.88 pW/Hz ^{1/2}	8 mV (12 mV Max)		
PDA36A2	0	1.51 kV/A	0.75 kV/A	12 MHz	258 μ V	75.7 pW/Hz ^{1/2}	5 mV (10 mV Max)	0 - 10 V	0 - 5 V
	10	4.75 kV/A	2.38 kV/A	1.6 MHz	192 μ V	5.8 pW/Hz ^{1/2}	6 mV (10 mV Max)		
	20	15 kV/A	7.5 kV/A	1 MHz	207 μ V	3.4 pW/Hz ^{1/2}	6 mV (10 mV Max)		
	30	47.5 kV/A	23.8 kV/A	260 kHz	211 μ V	3.4 pW/Hz ^{1/2}	6 mV (10 mV Max)		
	40	150 kV/A	75 kV/A	90 kHz	214 μ V	3.25 pW/Hz ^{1/2}	6 mV (10 mV Max)		
	50	475 kV/A	238 kV/A	28 kHz	234 μ V	3.69 pW/Hz ^{1/2}	6 mV (10 mV Max)		
	60	1.5 MV/A	750 kV/A	9 kHz	277 μ V	4 pW/Hz ^{1/2}	6 mV (10 mV Max)		
	70	4.75 MV/A	2.38 MV/A	3 kHz	388 μ V	4.29 pW/Hz ^{1/2}	8 mV (12 mV Max)		
FPD310-FS-VIS	0	-	2×10^4 V _{pp} /W	1 - 1500 MHz	- ^{c,d}	24.0 pW/Hz ^{1/2}	N/A (AC Coupling)	-	200 - 800 mV
	20	-	2×10^3 V _{pp} /W					-	20 - 800 mV

- Gain figures can also be expressed in units of Ω .

- The Noise Equivalent Power is specified at the peak wavelength.
- The Dark State Noise Level is -100 dBm (up to 5 MHz).
- The Dark State Noise Level is -130 dBm (5 to 1500 MHz).

[Hide Housing Features](#)

HOUSING FEATURES

Housing Features of the Amplified Si Photodetectors

Please refer to the table below for detailed drawings of each detector.

PDA and PDF Detectors

Thorlabs' Amplified Photodiode series feature a slim design with many common elements. Each housing features internal SM05 (0.535"-40) threading and external SM1 (1.035"-40) threading, and includes a detachable SM1T1 internally SM1-threaded adapter, as shown to the right. The SM1T1 can hold up to 0.1" (2.8 mm) thick optics. An SM1RR retaining ring is included with every detector, except the PDF10A(/M). Each detector can be mounted using a 1/2" Post, as shown in the images below. The PDF10A(/M) includes the TRE(TRE/M) electrically isolated Ø1/2" post adapter. Detectors with universal taps (refer to the table below) have a new housing design that features the active area flush with the front of the housing, simplifying alignments within optomechanical systems. As a convenience, the back panels of these detectors are engraved with the responsivity curve of the photodiodes.



Click to Enlarge
The housings of Thorlabs' detectors feature internal SM05 and external SM1 threads. An SM1T1 SM1 Adapter with internal threads is included with each amplified photodetector, and an SM1RR Retaining Ring is included with the PDA015A, PDA10A2, PDA36A2, and PDA100A2.



Click to Enlarge
Top of the housing on our PDA and PDF detector housings. The Power In connector, Output BNC connector, and power indicator LED are located at the top of the housing. The PDA015A detector is shown.

Lens Tube Compatibility

These detectors can be integrated into various optomechanical systems using the internal SM05 and external SM1 threads. A lens tube can be directly attached to the SM1 threads, making the detectors compatible with lens tube systems. The SM1T1 adapter can be used to mount Ø1" (Ø25.4 mm) optical components, such as optical filters and lenses.

Cage System Compatibility

The detectors are also cage system compatible, as shown in the two images below right. A CP33 cage plate can be attached directly to the SM1 threads. This attachment method does not require an adapter piece and allows the diode to be as close as possible to the cage plate, which can be important in setups where the light is divergent. Another method for integrating a detector into a cage system is using the included SM1T1 with an SM1T2 adapter. This allows more freedom in choosing the orientation of the detector. Additionally, these detectors can be used with SM1-threaded fiber adapters (sold below).

Post Mounting

Threaded holes on the housings of the detectors allow the units to be mounted in a horizontal or vertical orientation using a 1/2" Post. This gives the user the option to route the power and BNC cables from above or alongside the beam path, as shown below left. We offer detectors that have metric and imperial versions, as well as detectors that have universal mounting holes that accept 8-32 and M4 threads. Please see the table below for the specific mounting taps of each detector.



Click to Enlarge
PDA Photodetector Mounted Horizontally



Click to Enlarge
[APPLIST]
[APPLIST]
PDA Photodetector Connected to an SM1 Lens Tube in a 30 mm Cage System



Click to Enlarge
[APPLIST]
[APPLIST]
PDA Photodetector Integrated into a 30 mm Cage System Using the External SM1 Threads



Click to Enlarge
 [APPLIST]
 [APPLIST]
 PDA Photodetector Integrated into a 30 mm Cage System Using the SM1T1 (included) and SM1T2 Adapter

FPD Detectors

The housing of each of Menlo Systems' FPD detectors feature one M4 tapped hole on the bottom for post mounting. The power supply connector and output SMA connector are located on the side of the housing.

Detectors	Housing Drawing (Click Icon for Details)	Mounting Taps	SM Thread Compatibility	Dimensions	Output Connector
PDA/PDF Fixed Gain					
PDA8A2, PDA10A2		Two Universal Taps for 8-32 and M4	Internal SM05 (0.535"-40) External SM1 (1.035"-40)	1.96" x 0.89" x 2.79" (49.8 mm x 22.5 mm x 70.9 mm)	BNC
PDA015A		Two 8-32 Taps (M4 for Metric Version)		1.89" x 0.83" x 2.76" (48.0 mm x 21.1 mm x 70.2 mm)	
PDA8A, PDF10A		Three 8-32 Taps (M4 for Metric Version)		1.70" x 0.83" x 2.57" (43.2 mm x 21.1 mm x 65.3 mm)	
FPD Fixed Gain					
FPD510-FS-VIS, FPD610-FS-VIS		One M4 Tap	N/A	2.36" x 0.79" x 1.97" (60.0 mm x 20.0 mm x 50.0 mm)	SMA
PDA Switchable Gain					
PDA36A2, PDA100A2		Two Universal Taps for 8-32 and M4	Internal SM05 (0.535"-40) External SM1 (1.035"-40)	2.07" x 0.89" x 2.79" (52.5 mm x 22.5 mm x 70.9 mm)	BNC
FPD Switchable Gain					
FPD310-FS-VIS		One M4 Tap	N/A	2.36" x 0.79" x 1.97" (60.0 mm x 20.0 mm x 50.0 mm)	SMA

[Hide Pin Diagrams](#)

PIN DIAGRAMS

PDA and PDF Series Detectors

BNC Female Output (Photodetector)

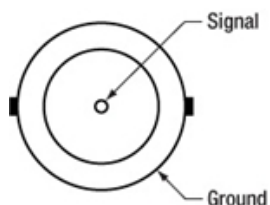

PDA10A2, PDA8A2, PDF10A, PDA015A, PDA100A2, PDA36A2: 0 - 10 V Output

Male (Power Cables)



Female Power IN (Photodetector)

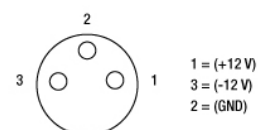

FPD Series Detectors

Signal Out- SMA Female

Female (Power Cables)

(Photodetector)

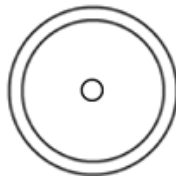

For connection to a suitable monitoring device, e.g. oscilloscope or RF-spectrum-analyzer, with 50 Ω impedance.

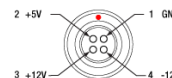

Male Power IN (Photodetector)

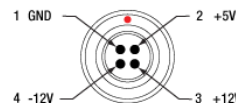

[Hide Photodiode Tutorial](#)

PHOTODIODE TUTORIAL

Photodiode Tutorial

Theory of Operation

A junction photodiode is an intrinsic device that behaves similarly to an ordinary signal diode, but it generates a photocurrent when light is absorbed in the depleted region of the junction semiconductor. A photodiode is a fast, highly linear device that exhibits high quantum efficiency based upon the application and may be used in a variety of different applications.

It is necessary to be able to correctly determine the level of the output current to expect and the responsivity based upon the incident light. Depicted in Figure 1 is a junction photodiode model with basic discrete components to help visualize the main characteristics and gain a better understanding of the operation of Thorlabs' photodiodes.

$$I_{OUT} = I_{DARK} + I_{PD}$$

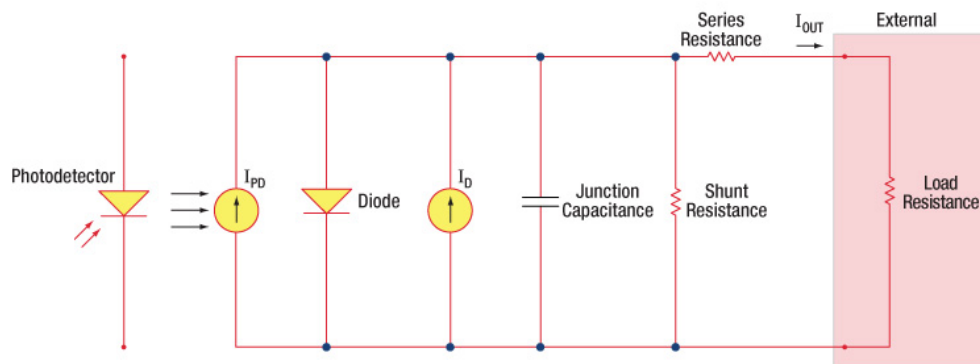

Figure 1: Photodiode Model

Photodiode Terminology

Responsivity

The responsivity of a photodiode can be defined as a ratio of generated photocurrent (I_{PD}) to the incident light power (P) at a given wavelength:

$$R(\lambda) = \frac{I_{PD}}{P}$$

Modes of Operation (Photoconductive vs. Photovoltaic)

A photodiode can be operated in one of two modes: photoconductive (reverse bias) or photovoltaic (zero-bias). Mode selection depends upon the application's speed requirements and the amount of tolerable dark current (leakage current).

Photoconductive

In photoconductive mode, an external reverse bias is applied, which is the basis for our DET series detectors. The current measured through the circuit

indicates illumination of the device; the measured output current is linearly proportional to the input optical power. Applying a reverse bias increases the width of the depletion junction producing an increased responsivity with a decrease in junction capacitance and produces a very linear response. Operating under these conditions does tend to produce a larger dark current, but this can be limited based upon the photodiode material. (Note: Our DET detectors are reverse biased and cannot be operated under a forward bias.)

Photovoltaic

In photovoltaic mode the photodiode is zero biased. The flow of current out of the device is restricted and a voltage builds up. This mode of operation exploits the photovoltaic effect, which is the basis for solar cells. The amount of dark current is kept at a minimum when operating in photovoltaic mode.

Dark Current

Dark current is leakage current that flows when a bias voltage is applied to a photodiode. When operating in a photoconductive mode, there tends to be a higher dark current that varies directly with temperature. Dark current approximately doubles for every 10 °C increase in temperature, and shunt resistance tends to double for every 6 °C rise. Of course, applying a higher bias will decrease the junction capacitance but will increase the amount of dark current present.

The dark current present is also affected by the photodiode material and the size of the active area. Silicon devices generally produce low dark current compared to germanium devices which have high dark currents. The table below lists several photodiode materials and their relative dark currents, speeds, sensitivity, and costs.

Material	Dark Current	Speed	Spectral Range	Cost
Silicon (Si)	Low	High Speed	Visible to NIR	Low
Germanium (Ge)	High	Low Speed	NIR	Low
Gallium Phosphide (GaP)	Low	High Speed	UV to Visible	Moderate
Indium Gallium Arsenide (InGaAs)	Low	High Speed	NIR	Moderate
Indium Arsenide Antimonide (InAsSb)	High	Low Speed	NIR to MIR	High
Extended Range Indium Gallium Arsenide (InGaAs)	High	High Speed	NIR	High
Mercury Cadmium Telluride (MCT, HgCdTe)	High	Low Speed	NIR to MIR	High

Junction Capacitance

Junction capacitance (C_j) is an important property of a photodiode as this can have a profound impact on the photodiode's bandwidth and response. It should be noted that larger diode areas encompass a greater junction volume with increased charge capacity. In a reverse bias application, the depletion width of the junction is increased, thus effectively reducing the junction capacitance and increasing the response speed.

Bandwidth and Response

A load resistor will react with the photodetector junction capacitance to limit the bandwidth. For best frequency response, a 50 Ω terminator should be used in conjunction with a 50 Ω coaxial cable. The bandwidth (f_{BW}) and the rise time response (t_r) can be approximated using the junction capacitance (C_j) and the load resistance (R_{LOAD}):

$$f_{BW} = 1 / (2 * \pi * R_{LOAD} * C_j)$$

$$t_r = 0.35 / f_{BW}$$

Noise Equivalent Power

The noise equivalent power (NEP) is the generated RMS signal voltage generated when the signal to noise ratio is equal to one. This is useful, as the NEP determines the ability of the detector to detect low level light. In general, the NEP increases with the active area of the detector and is given by the following equation:

$$NEP = \frac{\text{Incident Energy} * \text{Area}}{\frac{S}{N} * \sqrt{\Delta f}}$$

Here, S/N is the Signal to Noise Ratio, Δf is the Noise Bandwidth, and Incident Energy has units of W/cm². For more information on NEP, please see Thorlabs' Noise Equivalent Power White Paper.

Terminating Resistance

A load resistance is used to convert the generated photocurrent into a voltage (V_{OUT}) for viewing on an oscilloscope:

$$V_{OUT} = I_{OUT} * R_{LOAD}$$

Depending on the type of the photodiode, load resistance can affect the response speed. For maximum bandwidth, we recommend using a 50 Ω coaxial cable with a 50 Ω terminating resistor at the opposite end of the cable. This will minimize ringing by matching the cable with its characteristic impedance. If bandwidth is not important, you may increase the amount of voltage for a given light level by increasing R_{LOAD} . In an unmatched termination, the length of the coaxial cable can have a profound impact on the response, so it is recommended to keep the cable as short as possible.

Shunt Resistance

Shunt resistance represents the resistance of the zero-biased photodiode junction. An ideal photodiode will have an infinite shunt resistance, but actual values may range from the order of ten Ω to thousands of $M\Omega$ and is dependent on the photodiode material. For example, and InGaAs detector has a shunt resistance on the order of 10 $M\Omega$ while a Ge detector is in the $k\Omega$ range. This can significantly impact the noise current on the photodiode. For most applications, however, the high resistance produces little effect and can be ignored.

Series Resistance

Series resistance is the resistance of the semiconductor material, and this low resistance can generally be ignored. The series resistance arises from the contacts and the wire bonds of the photodiode and is used to mainly determine the linearity of the photodiode under zero bias conditions.

Common Operating Circuits

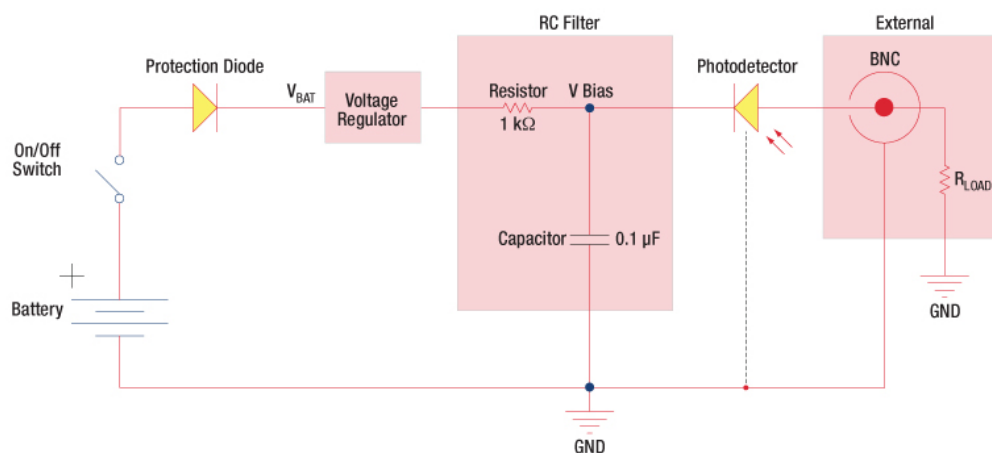

Figure 2: Reverse-Biased Circuit (DET Series Detectors)

The DET series detectors are modeled with the circuit depicted above. The detector is reverse biased to produce a linear response to the applied input light. The amount of photocurrent generated is based upon the incident light and wavelength and can be viewed on an oscilloscope by attaching a load resistance on the output. The function of the RC filter is to filter any high-frequency noise from the input supply that may contribute to a noisy output.

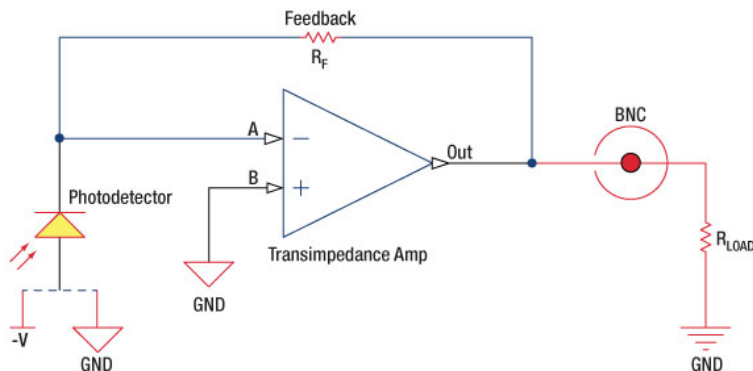

Figure 3: Amplified Detector Circuit

One can also use a photodiode with an amplifier for the purpose of achieving high gain. The user can choose whether to operate in Photovoltaic or Photoconductive modes. There are a few benefits of choosing this active circuit:

- Photovoltaic mode: The circuit is held at zero volts across the photodiode, since point A is held at the same potential as point B by the operational amplifier. This eliminates the possibility of dark current.
- Photoconductive mode: The photodiode is reversed biased, thus improving the bandwidth while lowering the junction capacitance. The gain of the detector is dependent on the feedback element (R_f). The bandwidth of the detector can be calculated using the following:

$$f(-3dB) = \sqrt{\frac{GBP}{4\pi * R_f * C_D}}$$

where GBP is the amplifier gain bandwidth product and C_D is the sum of the junction capacitance and amplifier capacitance.

Effects of Chopping Frequency

The photoconductor signal will remain constant up to the time constant response limit. Many detectors, including PbS, PbSe, HgCdTe (MCT), and InAsSb, have a typical $1/f$ noise spectrum (i.e., the noise decreases as chopping frequency increases), which has a profound impact on the time constant at lower frequencies.

The detector will exhibit lower responsivity at lower chopping frequencies. Frequency response and detectivity are maximized for

$$f_c = \frac{1}{2\pi\tau_r}$$

[Hide Previous Generation](#)

PREVIOUS GENERATION & NBSP ;

The following table lists Thorlab's selection of previous and current generation PDA and DET detectors.

Previous Generation Cross Reference of PDA and DET Detectors					
Wavelength	Material	Biased Detector		Amplified Detector	
		Current Generation	Previous Generation	Current Generation	Previous Generation
150 - 550 nm	GaP	DET25K2	DET25K(M)	PDA25K2	PDA25K(-EC)
200 - 1100 nm	Si	DET10A2	DET10A(M)	PDA10A2	PDA10A(-EC)
320 - 1100 nm	Si	DET100A2	DET100A(M) ^a	PDA100A2	PDA100A(-EC) ^b
	Si	-	-	PDA8A2	PDA8A
350 - 1100 nm	Si	DET36A2	DET36A(M)	PDA36A2	PDA36A(-EC)
500 - 1700 nm	InGaAs	DET10N2	DET10N(M)	-	-
800 - 1700 nm	InGaAs	DET20C2	DET20C(M)	PDA20CS2	PDA20CS(-EC)
		-	-	PDA05CF2	PDA10CF(-EC)
		-	-	PDA20C2	PDA20C(M)
800 - 1800 nm	Ge	DET30B2	DET30B(M)	PDA30B2	PDA30B(-EC)
		DET50B2	DET50B(M)	PDA50B2	PDA50B(-EC)
900 - 1700 nm	InGaAs	DET10C2	DET10C(M)	PDA10CS2	PDA10CS(-EC)
900 - 2600 nm	InGaAs	DET05D2	DET05D(M) ^c	PDA10D2	PDA10D(-EC) ^c
		DET10D2	DET10D(M) ^c	-	-

- The DET100A(M) wavelength range is 350 - 1100 nm.
- The PDA100A(-EC) wavelength range is 340 - 1100 nm.
- The DET05D(M), PDA10D(-EC), and DET10D(M) wavelength range is 800 - 2600 nm.

[Hide Pulse Calculations](#)

PULSE CALCULATIONS

Pulsed Laser Emission: Power and Energy Calculations

Determining whether emission from a pulsed laser is compatible with a device or application can require referencing parameters that are not supplied by the laser's manufacturer. When this is the case, the necessary parameters can typically be calculated from the available information. Calculating peak pulse power, average power, pulse energy, and related parameters can be necessary to achieve desired outcomes including:

- Protecting biological samples from harm.
- Measuring the pulsed laser emission without damaging photodetectors and other sensors.
- Exciting fluorescence and non-linear effects in materials.

Pulsed laser radiation parameters are illustrated in Figure 1 and described in the table. For quick reference, a list of equations are provided below. The document available for download provides this information, as well as an introduction to pulsed laser emission, an overview of relationships among the different parameters, and guidance for applying the calculations.

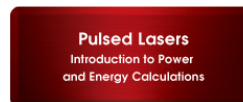

Click above to download the full report.

Equations:

Period and repetition rate are reciprocal: $\Delta t = \frac{1}{f_{rep}}$ and $f_{rep} = \frac{1}{\Delta t}$

Pulse energy calculated from average power: $E = \frac{P_{avg}}{f_{rep}} = P_{avg} \cdot \Delta t$

Average power calculated from pulse energy: $P_{avg} = \frac{E}{\Delta t} = E \cdot f_{rep}$

Peak pulse power estimated from pulse energy: $P_{peak} \approx \frac{E}{\tau}$

Peak power and average power calculated from each other:

$$P_{peak} = \frac{P_{avg}}{f_{rep} \cdot \tau} = \frac{P_{avg} \cdot \Delta t}{\tau} \quad \text{and} \quad P_{avg} = P_{peak} \cdot f_{rep} \cdot \tau = \frac{P_{peak} \cdot \tau}{\Delta t}$$

Peak power calculated from average power and duty cycle*:

$$P_{peak} = \frac{P_{avg}}{\tau / \Delta t} = \frac{P_{avg}}{\text{duty cycle}}$$

*Duty cycle ($\tau / \Delta t$) is the fraction of time during which there is laser pulse emission.

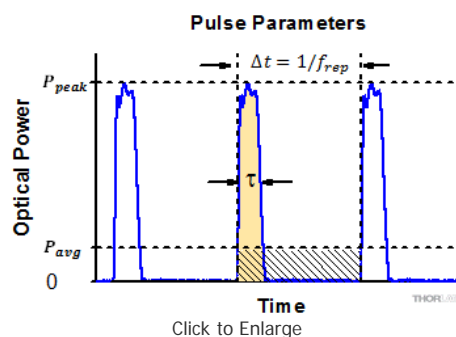

Figure 1: Parameters used to describe pulsed laser emission are indicated in the plot (above) and described in the table (below). **Pulse energy (E)** is the shaded area under the pulse curve. Pulse energy is, equivalently, the area of the diagonally hashed region.

Parameter	Symbol	Units	Description
-----------	--------	-------	-------------

Pulse Energy	E	Joules [J]	A measure of one pulse's total emission, which is the only light emitted by the laser over the entire period. The pulse energy equals the shaded area, which is equivalent to the area covered by diagonal hash marks.
Period	Δt	Seconds [s]	The amount of time between the start of one pulse and the start of the next.
Average Power	P_{avg}	Watts [W]	The height on the optical power axis, if the energy emitted by the pulse were uniformly spread over the entire period.
Instantaneous Power	P	Watts [W]	The optical power at a single, specific point in time.
Peak Power	P_{peak}	Watts [W]	The maximum instantaneous optical power output by the laser.
Pulse Width	τ	Seconds [s]	A measure of the time between the beginning and end of the pulse, typically based on the full width half maximum (FWHM) of the pulse shape. Also called pulse duration .
Repetition Rate	f_{rep}	Hertz [Hz]	The frequency with which pulses are emitted. Equal to the reciprocal of the period.

Example Calculation:

Is it safe to use a detector with a specified maximum peak optical input power of **75 mW** to measure the following pulsed laser emission?

- Average Power: 1 mW
- Repetition Rate: 85 MHz
- Pulse Width: 10 fs

The energy per pulse:

$$E = \frac{P_{avg}}{f_{rep}} = \frac{1 \text{ mW}}{85 \text{ MHz}} = \frac{1 \times 10^{-3} \text{ W}}{85 \times 10^6 \text{ Hz}} = 1.18 \times 10^{-11} \text{ J} = 11.8 \text{ pJ}$$

seems low, but the peak pulse power is:

$$P_{peak} = \frac{P_{avg}}{f_{rep} \cdot \tau} = \frac{1 \text{ mW}}{85 \text{ MHz} \cdot 10 \text{ fs}} = 1.18 \times 10^3 \text{ W} = \mathbf{1.18 \text{ kW}}$$

It is **not safe** to use the detector to measure this pulsed laser emission, since the peak power of the pulses is >5 orders of magnitude higher than the detector's maximum peak optical input power.

[Hide Cross Reference](#)

CROSS REFERENCE



The following table lists Thorlabs' selection of photodiodes and photoconductive detectors. Item numbers in the same row contain the same detector element.

Photodetector Cross Reference						
Wavelength	Material	Unmounted Photodiode	Unmounted Photoconductor	Mounted Photodiode	Biased Detector	Amplified Detector
150 - 550 nm	GaP	FGAP71	-	SM05PD7A	DET25K2	PDA25K2
200 - 1100 nm	Si	FDS010	-	SM05PD2A SM05PD2B	DET10A2	PDA10A2
	Si	-	-	SM1PD2A	-	-
320 - 1100 nm	Si	-	-	-	-	PDA8A2
	Si	FD11A	-	SM05PD3A	-	PDF10A(/M)
	Si	-	-	-	DET100A2	PDA100A2
340 - 1100 nm	Si	FDS10X10	-	-	-	-
	Si	FDS100	-	SM05PD1A	DET36A2	PDA36A2

350 - 1100 nm		FDS100-CAL ^a		SM05PD1B		
	Si	FDS1010 FDS1010-CAL ^a	-	SM1PD1A SM1PD1B	-	-
400 - 1000 nm	Si	-	-	-	-	PDA015A(/M) FPD310-FS-VIS FPD310-FC-VIS FPD510-FC-VIS FPD510-FS-VIS FPD610-FC-VIS FPD610-FS-VIS
400 - 1100 nm	Si	FDS015 ^b	-	-	-	-
	Si	FDS025 ^b FDS02 ^c	-	-	DET02AFC(/M) DET025AFC(/M) DET025A(/M) DET025AL(/M)	-
400 - 1700 nm	Si & InGaAs	DSD2	-	-	-	-
500 - 1700 nm	InGaAs	-	-	-	DET10N2	-
750 - 1650 nm	InGaAs	-	-	-	-	PDA8GS
800 - 1700 nm	InGaAs	FGA015	-	-	-	PDA015C(/M)
	InGaAs	FGA21 FGA21-CAL ^a	-	SM05PD5A	DET20C2	PDA20C2 PDA20CS2
	InGaAs	FGA01 ^b FGA01FC ^c	-	-	DET01CFC(/M)	-
	InGaAs	FDGA05 ^b	-	-	-	PDA05CF2
	InGaAs	-	-	-	DET08CFC(/M) DET08C(/M) DET08CL(/M)	PDF10C(/M)
800 - 1800 nm	Ge	FDG03 FDG03-CAL ^a	-	SM05PD6A	DET30B2	PDA30B2
	Ge	FDG50	-	-	DET50B2	PDA50B2
	Ge	FDG05	-	-	-	-
900 - 1700 nm	InGaAs	FGA10	-	SM05PD4A	DET10C2	PDA10CS2
900 - 2600 nm	InGaAs	FD05D	-	-	DET05D2	-
		FD10D	-	-	DET10D2	PDA10D2
950 - 1650 nm	InGaAs	-	-	-	-	FPD310-FC-NIR FPD310-FS-NIR FPD510-FC-NIR FPD510-FS-NIR FPD610-FC-NIR FPD610-FS-NIR
1.0 - 2.9 μm	PbS	-	FDPS3X3	-	-	-
1.0 - 5.8 μm	InAsSb	-	-	-	-	PDA10PT(-EC)
1.5 - 4.8 μm	PbSe	-	FDPSE2X2	-	-	PDA20H(-EC)
2.0 - 5.4 μm	HgCdTe (MCT)	-	-	-	-	PDA10JT(-EC)
2.0 - 8.0 μm	HgCdTe (MCT)	VML8T0 VML8T4 ^d	-	-	-	PDAVJ8
2.0 - 10.6 μm	HgCdTe (MCT)	VML10T0 VML10T4 ^d	-	-	-	PDAVJ10
2.7 - 5.0 μm	HgCdTe (MCT)	VL5T0	-	-	-	PDAVJ5
2.7 - 5.3 μm	InAsSb	-	-	-	-	PDA07P2

- Calibrated Unmounted Photodiode
- Unmounted TO-46 Can Photodiode
- Unmounted TO-46 Can Photodiode with FC/PC Bulkhead
- Photovoltaic Detector with Thermoelectric Cooler

Si Amplified Photodetectors, Fixed Gain







Item # ^a	Housing Features ^b	Wavelength Range	Bandwidth Range	Rise Time	Gain		NEP	Typical Performance Graphs	Active Area ^c	Operating Temperature Range	Power Supply Included
					Hi-Z Load	50 Ω Load					
PDA10A2		200 - 1100 nm ^d	DC - 150 MHz	2.3 ns	10 kV/A	5 kV/A	29.2 pW/Hz ^{1/2}		0.8 mm ² (Ø1 mm) ^e	10 to 50 °C	Yes
PDA8A2		320 - 1000 nm	DC - 50 MHz	7 ns	100 kV/A	50 kV/A	7.8 pW/Hz ^{1/2}		0.5 mm ² (Ø0.8 mm)	10 to 50 °C	Yes
PDF10A		320 - 1100 nm	DC - 20 Hz	22 ms	1 x 10 ⁹ kV/A	-	1.4 x 10 ⁻³ pW/Hz ^{1/2}		1.2 mm ² (1.1 x 1.1 mm)	18 to 28 °C	Yes
PDA015A		400 - 1000 nm	DC - 380 MHz	1.0 ns	50 kV/A	25 kV/A	36 pW/Hz ^{1/2}		0.018 mm ² (Ø150 μm)	10 to 40 °C	Yes
FPD510-FS-VIS		400 - 1000 nm	DC - 250 MHz	2 ns	-	1.5 x 10 ⁵ V/W	6.0 pW/Hz ^{1/2}		0.13 mm ² (Ø0.4 mm)	10 to 40 °C	Yes
FPD610-FS-VIS		400 - 1000 nm	DC - 600 MHz	1 ns	-	2 x 10 ⁶ V/W	11.2 pW/Hz ^{1/2}		0.13 mm ² (Ø0.4 mm)	10 to 40 °C	Yes

- Click on the links to view photos of the items.
- Click the icons for details of the housing.
- Click on the links to view photos of the detector elements.
- When long-term UV light is applied, the product specifications may degrade. For example, the product's UV response may decrease and the dark current may increase. The degree to which the specifications may degrade is based upon factors such as the irradiation level, intensity, and usage time.
- The detector active area surface is flush with the front the housing.

Part Number	Description	Price	Availability
PDF10A/M	Si fW Sensitivity Fixed Gain Detector, 320 - 1100 nm, 20 Hz BW, 1.2 mm ² , M4 Taps	\$870.02	Lead Time
PDA015A/M	Si Fixed Gain Detector, 400 - 1000 nm, 380 MHz BW, 0.018 mm ² , M4 Taps	\$949.51	Today
FPD510-FS-VIS	Si Fixed Gain, High Sensitivity PIN Detector, 400 - 1000 nm, 250 MHz BW, 0.13 mm ² , M4 Tap	\$1,870.19	Today
FPD610-FS-VIS	Si Fixed Gain, High Sensitivity PIN Detector, 400 - 1000 nm, 600 MHz BW, 0.13 mm ² , M4 Tap	\$1,870.19	Today
PDA10A2	Si Fixed Gain Detector, 200 - 1100 nm, 150 MHz BW, 0.8 mm ² , Universal 8-32 / M4 Taps	\$327.88	Today
PDA8A2	Si Fixed Gain Detector, 320 - 1000 nm, 50 MHz BW, 0.5 mm ² , Universal 8-32 / M4 Taps	\$441.50	Today
PDF10A	Si fW Sensitivity Fixed Gain Detector, 320 - 1100 nm, 20 Hz BW, 1.2 mm ² , 8-32 Taps	\$870.02	Today
PDA015A	Si Fixed Gain Detector, 400 - 1000 nm, 380 MHz BW, 0.018 mm ² , 8-32 Taps	\$949.51	Today

[Hide Si Amplified Photodetectors, Switchable Gain](#)

Si Amplified Photodetectors, Switchable Gain

Item # ^a	Housing Features ^b	Wavelength Range	Bandwidth Range	Gain		NEP	Typical Performance Graphs	Active Area (Click Link for Image)	Operating Temperature Range	Power Supply Included
				Hi-Z Load	50 Ω Load					
PDA100A2		320 - 1100 nm	DC - 11 MHz	1.51 kV/A - 4.75 MV/A ^c	0.75 kV/A - 2.38 MV/A ^c	2.67 - 71.7 pW/Hz ^{1/2}		75.4 mm ² (Ø9.8 mm)	10 to 40 °C	Yes
PDA36A2		350 - 1100 nm	DC - 12 MHz	1.51 kV/A - 4.75 MV/A ^c	0.75 kV/A - 2.38 MV/A ^c	3.25 - 75.7 pW/Hz ^{1/2}		13 mm ² (3.6 mm x 3.6 mm) ^d	10 to 40 °C	Yes
FPD310-FS-VIS		400 - 1000 nm	1 - 1500 MHz	-	2 x 10 ³ - 2 x 10 ⁴ V _{pp} /W ^e	24.0 pW/Hz ^{1/2}		0.13 mm ² (Ø0.4 mm)	10 to 40 °C	Yes

- Click on the links to view photos of the items.
- Click the icons for details.
- Switchable with 8 x 10 dB Steps. Bandwidth varies inversely with gain.
- The detector active area surface is flush with the front the housing.
- Switchable with 2 steps, 0 and 20 dB.

Part Number	Description	Price	Availability

FPD310-FS-VIS	Si Switchable Gain, High Sensitivity PIN Amplified Detector, 400 - 1000 nm, 1 MHz - 1.5 GHz BW, 0.13 mm ² , M4 Taps	\$1,870.19	Today
PDA100A2	Si Switchable Gain Detector, 320 - 1100 nm, 11 MHz BW, 75.4 mm ² , Universal 8-32 / M4 Taps	\$381.99	Today
PDA36A2	Si Switchable Gain Detector, 350 - 1100 nm, 12 MHz BW, 13 mm ² , Universal 8-32 / M4 Taps	\$347.36	Today

[Hide PDA Power Supply Cable](#)

PDA Power Supply Cable

The PDA-C-72 power cord is offered for the PDA line of amplified photodetectors when using with a power supply other than the one included with the detector. The cord has tinned leads on one end and a PDA-compatible 3-pin connector on the other end. It can be used to power the PDA series of amplified photodetectors with any power supply that provides a DC voltage. The pin descriptions are shown to the right.

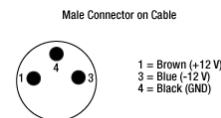

Part Number	Description	Price	Availability
PDA-C-72	72" PDA Power Supply Cable, 3-Pin Connector	\$21.10	Today

[Hide ±12 VDC Regulated Linear Power Supply](#)

±12 VDC Regulated Linear Power Supply

- ▶ Replacement Power Supply for the PDA and PDF Amplified Photodetectors Sold Above
- ▶ ±12 VDC Power Output
- ▶ Current Limit Enabling Short Circuit and Overload Protection
- ▶ On/Off Switch with LED Indicator
- ▶ Switchable AC Input Voltage (100, 120, or 230 VAC)
- ▶ 2 m (6.6 ft) Cable with LUMBERG RSMV3 Male Connector
- ▶ UL and CE Compliant

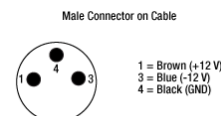

The LDS12B ±12 VDC Regulated Linear Power Supply is intended as a replacement for the supply that comes with our PDA and PDF line of amplified photodetectors sold on this page. The cord has three pins: one for ground, one for +12 V, and one for -12 V (see diagram above). A region-specific power cord is shipped with the LDS12B power supply based on your location. This power supply can also be used with the PDB series of balanced photodetectors, PMM series of photomultiplier modules, APD series of avalanche photodetectors, and the FSAC autocorrelator for femtosecond lasers.

Part Number	Description	Price	Availability
LDS12B	±12 VDC Regulated Linear Power Supply, 6 W, 100/120/230 VAC	\$85.22	Today

[Hide Internally SM1-Threaded Fiber Adapters](#)

Internally SM1-Threaded Fiber Adapters

These internally SM1-threaded (1.035"-40) adapters mate terminated fiber to any of our externally SM1-threaded components, including our photodiode power sensors, our thermal power sensors, and our photodetectors. These adapters are compatible with the housing of the photodetectors on this page.

The APC adapter has two dimples in the front surface that allow it to be tightened with the SPW909 or SPW801 spanner wrench. The dimples do not go all the way through the disk so that the adapter can be used in light-tight applications when paired with SM1 lens tubes.

Item #	S120-APC ^a	S120-SMA	S120-ST	S120-SC	S120-LC
Adapter Image (Click the Image to Enlarge)					
Fiber Connector Type	FC/APC ^b	SMA	ST/PC	SC/PC ^c	LC/PC
Thread	Internal SM1 (1.035"-40)				

- The S120-APC is designed with a 4° mechanical angle to compensate for the refraction angle of the output beam.
- This connector uses a wide key (2.2 mm).
- In certain angle-independent applications, this adapter may also be used with SC/APC connectors.

Part Number	Description	Price	Availability
S120-APC	Customer Inspired! FC/APC Fiber Adapter Cap with Internal SM1 (1.035"-40) Threads	\$32.96	Today
S120-SMA	SMA Fiber Adapter Cap with Internal SM1 (1.035"-40) Threads	\$42.20	Today
S120-ST	ST/PC Fiber Adapter Cap with Internal SM1 (1.035"-40) Threads	\$42.20	Today
S120-SC	SC/PC Fiber Adapter Cap with Internal SM1 (1.035"-40) Threads	\$53.02	Today
S120-LC	LC/PC Fiber Adapter Cap with Internal SM1 (1.035"-40) Threads	\$53.02	Today

[Hide Externally SM1-Threaded Fiber Adapters](#)

Externally SM1-Threaded Fiber Adapters

- ▶ Externally SM1-Threaded (1.035"-40) Disks with FC/PC, FC/APC, SMA, ST/PC, SC/PC, or LC/PC Receptacle
- ▶ Light-Tight When Used with SM1 Lens Tubes
- ▶ Compatible with Many of Our 30 mm Cage Plates and Photodetectors

Each disk has four dimples, two in the front surface and two in the back surface, that allow it to be tightened from either side with the SPW909 or SPW801 spanner wrench. The dimples do not go all the way through the disk so that the adapters can be used in light-tight applications when paired with SM1 lens tubes. Once the adapter is at the desired position, use an SM1RR retaining ring to secure it in place.

Item #	SM1FC	SM1FCA ^a	SM1SMA	SM1ST	SM1SC1	SM1LC
Adapter Image (Click the Image to Enlarge)						
Connector Type	FC/PC	FC/APC ^b	SMA	ST/PC	SC/PC ^c	LC/PC
Threading	External SM1 (1.035"-40)					

- The SM1FCA is designed with a 4° mechanical angle to compensate for the refraction angle of the output beam.
- This connector uses a wide key (2.2 mm).
- In certain angle-independent applications, this adapter may also be used with SC/APC connectors.

Part Number	Description	Price	Availability
SM1FC	FC/PC Fiber Adapter Plate with External SM1 (1.035"-40) Threads	\$31.38	Today
SM1FCA	FC/APC Fiber Adapter Plate with External SM1 (1.035"-40) Threads	\$33.28	Today
SM1SMA	SMA Fiber Adapter Plate with External SM1 (1.035"-40) Threads	\$31.38	Today
SM1ST	ST/PC Fiber Adapter Plate with External SM1 (1.035"-40) Threads	\$29.18	Today
SM1SC1	SC/PC Fiber Adapter Plate with External SM1 (1.035"-40) Threads	\$59.74	Today
SM1LC	LC/PC Fiber Adapter Plate with External SM1 (1.035"-40) Threads	\$59.74	Today