

56 Sparta Avenue • Newton, New Jersey 07860
 (973) 300-3000 Sales • (973) 300-3600 Fax
 www.thorlabs.com



CM1001 - April 18, 2017

Item # CM1001 was discontinued on April 18, 2017. For informational purposes, this is a copy of the website content at that time and is valid only for the stated product.

CERNA™ MICROSCOPE WITH SINGLE-CUBE EPI-ILLUMINATOR

- ▶ Equipped with Single-Cube Epi-Illuminator
- ▶ Ready to Accept Objectives, Cameras, Filters, and Illumination Sources

Modular and Configurable



CM1001
 Cerna™ Microscope
 (Optical Table Not Included)

[Hide Overview](#)

OVERVIEW

Features

- Single-Cube Epi-Illuminator
 - Compatible with Thorlabs' Mounted LEDs
 - Accepts Ø3 mm Liquid Light Guides
- Accepts C-Mount Cameras from Thorlabs and Most Major Manufacturers
- Motorized Focus Control of the Objective
- Trinoculars with 10X Eyepieces

The CM1001 Cerna™ Microscope provides a preconfigured optical path that is ideal for experiments requiring epi-illumination or reflected-light imaging. The epi-illumination module accepts a variety of LEDs and lamps equipped with Ø3 mm liquid light guides, while the 350 mm tall microscope body has ample space beneath the objective for adding Thorlabs' sample stages, micromanipulators, and other accessories needed for your experiment. A motorized objective holder provides 1" of vertical focusing adjustment for the objective.

Trinoculars with a 1X camera port support real-time viewing of the sample directly through the eyepieces. The C-mount-threaded camera port is compatible with most industry-standard cameras, which can be used to view the sample on a computer screen in real time or to capture images to analyze later.

Unlike competing microscopes with similar capabilities, the Cerna platform's modularity lets the user quickly install and remove the microscope modules as needed for each experiment, providing a high degree of access and control. The open space beneath the objective provides ample room for *in vivo* imaging. Alternatively, *in vitro* samples can be studied by positioning sample stages below the objective using fixed arms that can be attached directly to the microscope or rigid stands. A variety of mounting surfaces are offered, allowing custom components to be integrated with your experiment.

To address a wide range of experimental parameters, Thorlabs offers eight preconfigured Cerna microscopes, which are summarized in the table below. In addition, we can work with you to configure a microscope that meets your unique needs. To contact our team, please e-mail ImagingSales@thorlabs.com. We also offer Cerna components individually for customers interested in building their own microscope.



Click to Enlarge
 A side view of the CM1001 Cerna™ Microscope
 (Optical Table Not Included)

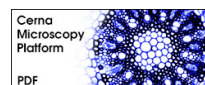

Cerna™ Microscopes	CM1001	CM1002	CM1003	CM2001	CM2002	CM3001	CM3002	CM3003(M)
Objective Holder	Single	Single	Single	Dual	Dual	Dual	Dual	Dual
Epi-Illumination	1 Cube	Up to 6 Cubes	1 Cube	Up to 6 Cubes	Up to 6 Cubes	Up to 6 Cubes	Up to 6 Cubes	Up to 6 Cubes
Trans-Illumination	-	-	Brightfield (Visible)	Brightfield (Visible)	Dot Contrast and Brightfield (Visible)	Dot Contrast and Brightfield (Visible and NIR)	DIC Imaging and Brightfield (Visible and NIR)	DIC Imaging and Brightfield (Visible and NIR)
XY Motion	-	-	-	-	-	Microscope Translator	-	Translating Platform

[Hide Microscope Design](#)

MICROSCOPE DESIGN

CM1001 Cerna™ Microscope

Entirely constructed from our line of modular components, this Cerna™ microscope includes several convenient features for imaging, which are highlighted below. We also offer a selection of microscope objectives, cameras, and illumination modules that can be used to complement your CM1001 Cerna microscope and customize it to your experiment. Details can be found on the *Accessories* tab. The *Shipping List* tab details the components used in this microscope, as well as a link to each component's webpage, where additional information (such as mechanical drawings) is available.

Epi-Illumination**Features**

- Single-Cube Epi-Illuminator Module (Filter Cubes and Sets Sold Separately)
- Accepts Thorlabs' Mounted LEDs or Lamps that Use Ø3 mm Liquid Light Guides

The epi-illumination module couples light emitted by the illumination source into the imaging path, through the objective, and onto the sample; it also allows epi-fluorescence generated by the sample to pass through the module to the eyepieces and camera. This epi-illuminator accepts one filter cube, making it suitable for several imaging modalities that require a single filter set. By installing a dichroic mirror and two emission filters, fluorescence imaging of a single fluorophore is possible. This filter set can be replaced with a 50:50 beamsplitter and two polarizers to create a reflected light imaging microscope. Alternatively, a multiband filter set combined with illumination from a multi-wavelength LED source allows the CM1001 Cerna Microscope to image samples with multiple fiducial markers. For more details about epi-illumination options offered by Thorlabs, please see the full web presentation.

Add-Ons: Epi-Illumination

- Illumination Sources
 - Lamps with Ø3 mm Liquid Light Guides
 - Mounted LEDs
 - X-Cite Lamps
- Epi-Fluorescence Filter Cube
- Epi-Fluorescence Filter Sets



Click to Enlarge
The CM1001 Cerna™ microscope features a single-cube epi-illuminator.



Click to Enlarge
The front cover of the epi-illuminator is removed by unscrewing two M2 screws to install a filter cube (not included). Magnets on the cover and the housing ensure that the filter cube is positioned correctly when the door is replaced.



Click to Enlarge
The back of the epi-illuminator includes a removable, SM1-threaded adapter that accepts liquid light guides.

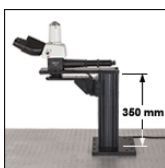

Click to Enlarge
The microscope body is based on a 95 mm optical rail.

Microscope Body Features

- Large Working Volume: Optical Path is 7.74" (196.6 mm) Away from Edge of Rail
- Linear Dovetail Surface Allows Modules to be Added and Removed
- 350 mm Body Height to Accommodate Sample Stages Mounted on Rigid Stands or Fixed Arms
- Motorized Objective Focusing Module with 1" Travel
- Mechanically Compatible with Thorlabs' 95 mm Rail Platforms

The backbone of the CM1001 Cerna™ Microscope is the 350 mm tall microscope body based on Thorlabs' 95 mm Optical Rails, providing stable long-term support and excellent vibrational damping. Its linear dovetail mounting surface allows modules to be removed when they are not needed, freeing additional workspace and opening the door to user customization. For alternate rail heights, please see the full web presentation.



Click to Enlarge
This Cerna™ microscope includes trinoculars with a 1X camera port for widefield viewing.

Widefield Viewing Features

- Trinoculars for Viewing Visible Light from the Sample
- Fixed 1X Magnification Camera Port with C-Mount Accepts Most Industry-Standard Cameras
- 10X Eyepiece Magnification and Adjustable Interpupil Distance

Add-On: Widefield Viewing

- Scientific Cameras

Widefield viewing on the CM1001 Cerna™ Microscope is provided by trinoculars and a 1X Camera Tube. The eyepieces feature an adjustable interpupil distance and rotate individually to allow the focus to be coarsely adjusted for each eye. The total system magnification for an image viewed through the eyepieces will be the objective magnification multiplied by 10.

The included camera tube contains all of the optics needed to image the light from the objective onto a camera sensor. The tube has 1X magnification, which means that the image will match the design field of view of the chosen widefield objective. External C-mount (1.000-32") threads on the top of the camera tube accept Thorlabs' scientific cameras, as well as cameras from most major manufacturers. For additional viewing port and camera tube options, please see the full web presentation.



Click to Enlarge
The CM1001 Cerna™ Microscope has a single objective holder (objective not included).

Objective Holders and Objectives Features

- Threaded for M32 x 0.75 Objectives
- Included Adapters:
 - M25 x 0.75-Threaded Objectives (Nikon)
 - RMS-Threaded Objectives (Olympus)

Add-On: Objectives

- Microscope Objectives

The Single-Objective Nosepiece connects to the motorized mounting arm on the microscope body via six M4 counterbores to provide 1" of motorized vertical translation of the objective. The nosepiece features an M32 x 0.75 threaded port for mounting objectives and includes two adapters to provide compatibility with other common objective threads: M25 x 0.75 (Nikon) and RMS (Olympus). Microscope objectives are available for purchase separately from Thorlabs, and we can also order other objectives from either Nikon or Olympus upon request. To mount multiple objectives, please see the full web presentation for other mounting options.

[Hide Accessories](#)

ACCESSORIES

Selected Accessories

In order to image with this microscope, it is necessary to add scientific cameras, an epi-illumination source, filter cubes and filter sets, objectives, and sample holders. It is often possible to improve the quality of your experimental data by carefully selecting accessories that complement your specific experiment. To that end, we have ensured that Cerna microscopes are compatible with a wide range of accessories. The information below compares the Cerna-compatible components that are manufactured or sold by Thorlabs. We have also indicated when it is possible to use equipment designed by other manufacturers.

Content

- Scientific Cameras for Widefield Viewing
- Illumination Sources for Epi-Illumination
- Filter Cubes and Filter Sets for Epi-Fluorescence
- Objectives
- Sample Holders

Scientific Cameras for Widefield Viewing

- Visualize the Field of View at a Computer
- Any C-Mount Camera is Compatible with a Cerna Microscope

Thorlabs offers scientific cameras optimized for a range of imaging needs. Cameras allow the field of view to be displayed on a computer screen and saved for later reference. Viewing your sample from a computer also enables remote sample positioning using our motion control accessories (see below), allowing samples to be moved in sensitive setups without introducing additional vibrations from your hands.

The CM1001 Cerna™ includes a 1X camera tube, which provides a fixed magnification at the image plane that is equal to the objective magnification.

Any camera with C-Mount (1.000"-32) threading is compatible with this microscope. The most popular cameras used with Cerna systems are given in the table below. Higher resolution options can be found in our complete range of scientific cameras.

Application-Optimized Cerna™ Microscopes

[Contact Us](#)

Developed in collaboration with our colleagues in the field, the Cerna microscopy platform is uniquely modular and flexible, making it adaptable to a wide range of demanding experimental requirements. If you would like to work with our application specialists, engineers, and sales team to design your own microscope, please email ImagingSales@thorlabs.com.



Click to Enlarge
The camera port provides fixed 1X magnification for visible light from the sample.

Item #	DCU224M	340M-USB	1501M-USB
Product Photo (Click to Enlarge)			
Primary Feature	Lightweight	Fast Frame Rate	High Resolution and Dynamic Range
Sensor Type	Sony ICX205AL	On Semi / Truesense KAI-0340 Monochrome CCD	Sony ICX285AL Monochrome CCD (Grade 0)
Sensor Format	1/2" (7.62 mm Diagonal)	1/3" Format (5.92 mm Diagonal)	2/3" Format (11 mm Diagonal)
Resolution	1280 x 1024 Pixels	640 x 480 Pixels	1392 x 1040 Pixels
Pixel Size	4.65 μm x 4.65 μm	7.4 μm x 7.4 μm	6.45 μm x 6.45 μm
Frame Rate (Max)	15 fps	200.7 fps	23 fps
Host PC Interface	USB 2.0 (Cable Included)	USB 3.0 (Cable Included)	
Digital Output	8 Bits	14 Bit	14 Bits
Mass	96 g (0.21 lbs)	750 g (1.65 lbs)	

Illumination Sources for Epi-Illumination

Illumination sources, filter cubes, and filter sets are available separately from the CM1001 Cerna™ microscope, allowing you to customize the illumination to the needs of your experiment. Compatible options are outlined below.

Light Sources: LEDs

- Long Lifetimes (>10,000 Hours for LEDs Shown Here)
- Output can be Modulated with Suitable Driver
- Integrated EEPROM for Automated Driver Configuration

The epi-illuminator on the CM1001 Cerna microscope is compatible with Thorlabs' LEDs. Selected LEDs that emit at important visible and NIR wavelengths are outlined in the table below. We offer a much wider range of LEDs than the five presented here, at wavelengths from 280 nm to 1550 nm, all of which are compatible with the CM1001 Cerna microscope. For our full selection, please see their full web presentation. Please note that the drivers needed to power the LEDs are sold separately.



Click to Enlarge
A Thorlabs' Mounted LED can be threaded into the epi-illuminator and secured using the included locking ring.

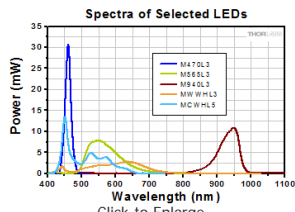

The spectra of selected Thorlabs LEDs scaled for reference. The graph is intended to be used as a guideline to compare the spectra of different LEDs.

Selected LEDs			
Item # ^a	Color ^{b,c}	Output Power (Typical) ^b	Compatible Drivers
M470L3	Blue (470 nm)	710 mW	LEDD1B DC2200 DC4100 DC4104
M565L3	Lime Green (565 nm)	979 mW	
M940L3	IR (940 nm)	1000 mW	
MWVHL3	Warm White (3000 K ^d)	550 mW	
MCWHL5	Cold White (6500 K ^d)	840 mW	

Full Web Presentation for Mounted LEDs

We offer a much wider range of LEDs than the five presented here, at wavelengths from 280 nm to 1550 nm. For our full selection, please see their full web presentation.

Output power and nominal wavelength specs are only intended to be used as a guideline. The output power is specified before the light from the LED enters the optical path of the microscope.

For LEDs in the visible spectrum, the nominal wavelength indicates the wavelength at which the LED appears brightest to the human eye. For IR LEDs, the nominal value corresponds to the peak wavelength.

Correlated Color Temperature

Light Sources: Liquid Light Guide Lamps

- White Light Sources Illuminate the Field of View Through the Objective
- Plasma Light Source with Output Spectrum from 350 - 800 nm
- X-CITE 200 Lamp with Output Spectrum from 340 - 800 nm



Click to Enlarge
The liquid light guide can be secured by tightening the thumbscrew on the included adapter.

Our selection of lamps incorporate flexible liquid light guides (or LLGs) to deliver broad spectrum visible light into the epi-illuminator. Their broadband emission makes them best suited for setups that require the flexibility to stimulate fluorophores that have absorption wavelengths that are spectrally separated. They are designed to be used in combination with filter cubes loaded into the epi-illuminator, which help condition the light from the lamp to target specific fluorophores. The epi-illuminator in the CM1001 Cerna microscope includes an adapter that directly accepts the LLG; simply insert the LLG and secure it using the included thumbscrew.



Click to Enlarge

HPLS343 Features

- ▶ Output Spectrum: 350 - 800 nm
- ▶ Intensity is Variable from 0.1% to 100% Using Knob
- ▶ External Control via USB 2.0 or BNC Inputs
- ▶ Lifetime: 10,000 Hours (Average)
- ▶ Includes Ø3 mm, 1.2 m (4') Long LLG
- ▶ Link to Full Web Presentation



Click to Enlarge

XCITE200DC Features

- ▶ Output Spectrum: 340 - 800 nm
- ▶ Intensity is Variable from 0% to 100% Using Knob
- ▶ External Control via BNC Input
- ▶ Lifetime: >2,000 Hours Minimum; >2,500 Hour Typical
- ▶ Includes Ø3 mm, 5' (1.5 m) Long LLG and Nikon Bayonet Mount
- ▶ Link to Full Web Presentation

Filter Cubes and Filter Sets

- Tune Epi-Illumination Source for the Excitation and Detection of Specific Fluorophores
- Easily Mount Filter Sets in the TLV-U-MF2
- Select Filter Sets Available Pre-Installed in Microscope Filter Cubes
- Each Thorlabs Set Consists of an Excitation Filter, an Emission Filter, and a Dichroic Mirror
- Cerna™ Microscopes are Compatible with Fluorescence Filters from All Major Manufacturers
- Other Filter Sets Available



Click to Enlarge
Filter Cube in Single-Cube Epi-Illuminator

The epi-illumination module included with the CM1001 Cerna™ microscope accepts the TLV-U-MF2 Filter Cube. This filter cube is designed to hold one Ø25 mm emission filter (up to 5 mm thick), one Ø25 mm excitation filter (up to 3.5 mm thick), and one 25 mm x 36 mm dichroic mirror (up to 1.1 mm thick), as shown in the video below, allowing Cerna microscopes to be compatible with filters from all major manufacturers.

Several popular filter sets are listed with their target fluorophores in the table below. Each set includes an excitation filter, an emission filter, and a dichroic mirror. Thorlabs fluorescence filter sets can be pre-mounted in the TLV-U-MF2 filter cube free of charge if all items are purchased at the same time; contact Technical Support prior to ordering to take advantage of this option.

Installation of a Filter Set and Filter Cube into the Single-Cube Epi-Illuminator

Item #	Accepted Filter Sizes
TLV-U-MF2	Excitation Ø25 mm, ≤5 mm Thickness Emission: Ø25 mm, ≤3.5 mm Thickness Dichroic Mirror: 25.2 mm x 36.0 mm, ≤1.1 mm Thickness

Selected Compatible Fluorescence Filter Sets ^a		
Item #	Target Fluorophore	Transmission Graph (Click for Plot)
MDF-BFP	BFP (Blue Fluorescent Protein)	
MDF-GFP2	Alexa Fluor® 488, GFP	
MDF-MCHA ^b	mCherry	
MDF-MCHC ^c	mCherry	
MDF-TOM	tdTomato	

- a. Please see the full web presentation for a complete listing of fluorescence filter sets offered.
- b. This filter set's excitation range is centered around 578 nm, making it well matched to typical LEDs.
- c. This filter set's excitation range is centered around 562 nm, making it well matched to typical lamps.

Objectives

- Cerna™ CM1001 Microscope Directly Accepts Objectives with M32 x 0.75 Threads
- Includes Thread Adapters for Compatibility with Objectives from Major Manufacturers
 - M25 x 0.75-Threaded Objectives (Nikon)
 - RMS-Threaded Objectives (Olympus)

The nospiece of this microscope has one M32 x 0.75-threaded bore for mounting objectives. The M32 x 0.75 thread standard is used by newer widefield microscope objectives and offers larger back apertures than previous standards. M25 x 0.75- and RMS-threaded adapters are included for compatibility with most objectives from Olympus and Nikon. Shown below are selected widefield Nikon objectives that are commonly used with the CM1001 Cerna Microscope. They can be mounted in the microscope's CSA1100 single-objective holder using the included M32 x 0.75 to M25 x 0.75 adapter. We offer other objectives and can order other objectives from either Nikon or Olympus upon request.

Item #	N4X-PF	N10X-PF	N20X-PF	N40X-PF	N60X-PF
Photo (Click to Enlarge)					
Magnification	4X	10X	20X	40X	60X
Numerical Aperture (NA)	0.13	0.3	0.50	0.75	0.85
Working Distance (WD)	17.2 mm	16 mm	2.1 mm	0.66 mm	0.31 - 0.4 mm
Threading	M25 x 0.75				

Sample Stages and Holders

- Rigid Stands to Hold Samples Underneath and Around the Objectives
 - Designed for Slides, Petri Dishes, Well Plates, Recording Chambers, Micromanipulators, and Custom Inserts
 - Translation Stages with 1" of X and Y Travel Available
- Fixed Arms Allow Fast XY Stage, Lens Tubes, and/or Cage Systems to be Placed Directly Into the Optical Path
 - CSA1000: For Our MLS203-1 Fast XY Scanning Stage
 - CSA1001: For Ø1" Lens Tubes and 30 mm Cage Systems
 - CSA1002: For Ø2" Lens Tubes and 60 mm Cage Systems



Click to Enlarge
MP100-MLSH Rigid Stand with
MLS203P2 Slide/Petri Dish
Holder



Click to Enlarge
MLS203-1 Stage with
MLS203P2 Slide Holder on
CSA1000 Fixed Arm
(All Sold Separately)



Click for Details
MP100-RCH2 Slide Holder in a
Cerna Microscope

Thorlabs offers highly configurable solutions for mounting your sample beneath the objective of the Cerna™ Microscope. Rigid stands are available with multiple platform styles that can accept slides, petri dishes, recording chambers, micromanipulators, and custom inserts. The included collar makes them lockable at a height and angle chosen by the user. We also manufacture translation stages for these rigid stands that provide motorized horizontal translation of the sample.

Our fixed arms enable the sample stage to be attached directly to the microscope body via a dovetail that extends the full height of the microscope body, allowing the arms to be positioned anywhere along the body height. For a pre-configured sample holder solution, use the CSA1000 fixed arm with the MLS203-1 Fast XY Scanning Stage. This stage is compatible with our MZS500-E Piezo-Driven Insert, which adds high-resolution Z-axis adjustments. Alternatively, the CSA1001 and CSA1002 rigid arms are compatible with Thorlabs' wide selection of optomechanical components, allowing custom sample holder configurations and additional optics to be easily integrated the CM1001 Cerna microscope.

Several common options are outlined below, while our full selection of sample holders can be explored in the Cerna Components presentation.

Rigid Stands



[Click to Enlarge](#)

MP100-RCH2 Slide Holder

- ▶ Designed for Standard 3" x 1" (76.2 mm x 25.4 mm) Microscope Slides
- ▶ Height Range: 148.1 - 208.5 mm
- ▶ Other Heights Available



[Click to Enlarge](#)

MP100-MLSH Insert Holder

- ▶ Designed for Multiple Slides, Petri Dishes, Well Plates, Calibration Targets, Breadboards, Our MZS500-E Z-Axis Piezo Stage, and User-Designed Inserts
- ▶ Height Range: 148.1 - 208.5 mm
- ▶ Other Heights Available



[Click to Enlarge](#)

MP100-RCH1 Recording Chamber Holder

- ▶ Circular Hole Designed for Recording Chambers
- ▶ Height Range: 148.1 - 208.5 mm
- ▶ Other Heights Available



[Click to Enlarge](#)

MP100 Rigid Stand with Platform

- ▶ 24 M6 x 1.0 Tapped Holes for Holding Micromanipulators or Other Equipment
- ▶ Height Range: 148.1 - 208.5 mm
- ▶ Other Heights Available

Fixed Arms



[Click to Enlarge](#)

CSA1000 Fixed Arm

- ▶ Accepts MLS203-1 Fast XY Scanning Stage



[Click to Enlarge](#)

CSA1001 Fixed Arm

- ▶ Compatible with Ø1" Lens Tubes and 30 mm Cage Systems



[Click to Enlarge](#)

CSA1002 Fixed Arm

- ▶ Compatible with Ø2" Lens Tubes and 60 mm Cage Systems

[Hide Shipping List](#)

SHIPPING LIST

The microscope on this webpage is entirely constructed from our selection of modular Cerna™ components. This tab lists all of the components that the microscope contains.

Item #	Description	Photo (Click to Enlarge)
Microscope Body		
CEA1350	Cerna™ Microscope Body with Epi-Illumination Arm, 350 mm Rail Height	
Widefield Viewing		
WFA4000	Trinoculars with Eyepieces	
WFA4105	1X Camera Tube with C-Mount	
Epi-Illumination		
WFA2001	Single-Cube Epi-Illuminator Module (Filter Cube Not Included)	
Objective Holder		
CSA1100	Single-Objective Nosepiece	
ZFM2020	Motorized Focusing Module with 1" Travel	

MCM3001

3-Axis Controller for Focus Control

[Hide Microscope Guide](#)

MICROSCOPE GUIDE

Elements of a Microscope

This overview was developed to provide a general understanding of a Cerna microscope. Click on the different portions of the microscope graphic to the right or use the links below to learn how a Cerna microscope visualizes a sample.

- Terminology
- Microscope Body
- Illumination
- Sample Viewing/Recording
- Sample/Experiment Mounting

Terminology

Arm: Holds components in the optical path of the microscope.

Bayonet Mount: A form of mechanical attachment with tabs on the male end that fit into L-shaped slots on the female end.

Bellows: A tube with accordion-shaped rubber sides for a flexible, light-tight extension between the microscope body and the objective.

Breadboard: A flat structure with regularly spaced tapped holes for DIY construction.

Dovetail: A form of mechanical attachment for many microscopy components. A linear dovetail allows flexible positioning along one dimension before being locked down, while a circular dovetail secures the component in one position. See the *Microscope Dovetails* tab or here for details.

Epi-Illumination: Illumination on the same side of the sample as the viewing apparatus. Epi-fluorescence, reflected light, and confocal microscopy are some examples of imaging modalities that utilize epi-illumination.

Filter Cube: A cube that holds filters and other optical elements at the correct orientations for microscopy. For example, filter cubes are essential for fluorescence microscopy and reflected light microscopy.

Köhler Illumination: A method of illumination that utilizes various optical elements to defocus and flatten the intensity of light across the field of view in the sample plane. A condenser and light collimator are necessary for this technique.

Nosepiece: A type of arm used to hold the microscope objective in the optical path of the microscope.

Optical Path: The path light follows through the microscope.

Rail Height: The height of the support rail of the microscope body.

Throat Depth: The distance from the vertical portion of the optical path to the edge of the support rail of the microscope body. The size of the throat depth, along with the working height, determine the working space available for microscopy.

Trans-Illumination: Illumination on the opposite side of the sample as the viewing apparatus. Brightfield, differential interference contrast (DIC), Dodt gradient contrast, and darkfield microscopy are some examples of imaging modalities that utilize trans-illumination.

Working Height: The height of the support rail of the microscope body plus the height of the base. The size of the working height, along with the throat depth, determine the working space available for microscopy.

Microscope Body

The microscope body provides the foundation of any Cerna microscope. The support rail utilizes 95 mm rails machined to a high angular tolerance to ensure an aligned optical path and perpendicularity with the optical table. The support rail height chosen (350 - 600 mm) determines the vertical range available for experiments and microscopy components. The 7.74" throat depth, or distance from the optical path to the support rail, provides a large working space for experiments. Components attach to the body by way of either a linear dovetail on the support rail, or a circular dovetail on the epi-

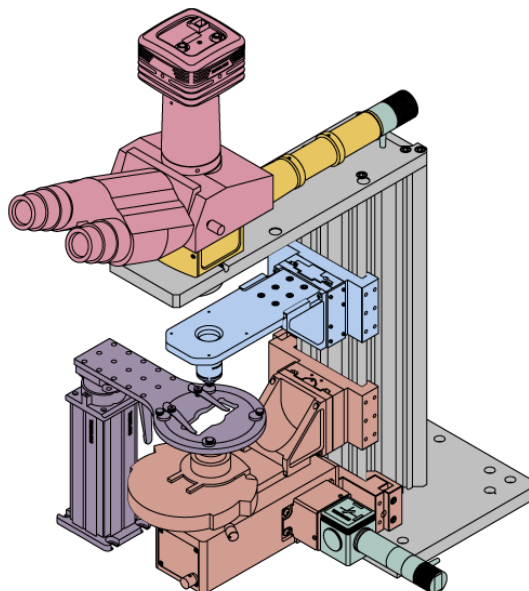

Click on the different parts of the microscope to explore their functions.

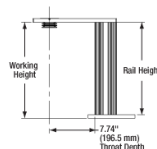

Click to Enlarge

illumination arm (on certain models). Please see the *Microscope Dovetails* tab or here for further details.

Body Details

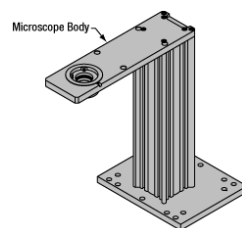

Enlarge
Cerna Microscope Body

Click to



Illumination

Using the Cerna microscope body, a sample can be illuminated in two directions: from above (epi-illumination, see yellow components to the right) or from below (trans-illumination, see orange components to the right).

Epi-illumination illuminates on the same side of the sample as the viewing apparatus; therefore, the light from the illumination source (green) and the light from the sample plane share a portion of the optical path. It is used in fluorescence, confocal, and reflected light microscopy. Epi-illumination modules, which direct and condition light along the optical path, are attached to the epi-illumination arm of the microscope body via a circular D1N dovetail (see the *Microscope Dovetails* tab or here for details). Multiple epi-illumination modules are available, as well as breadboard tops, which have regularly spaced tapped holes for custom designs.

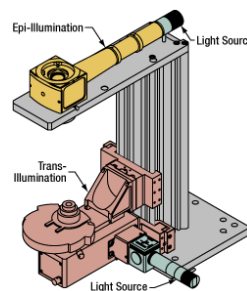

Enlarge
Illumination with a Cerna microscope can come from above (yellow) or below (orange). Illumination sources (green) attach to either.

Click to

Trans-illumination illuminates from the opposite side of the sample as the viewing apparatus. Example imaging modalities include brightfield, differential interference contrast (DIC), Dot gradient contrast, oblique, and darkfield microscopy. Trans-illumination modules, which condition light (on certain models) and direct it along the optical path, are attached to the support rail of the microscope body via a linear dovetail (see *Microscope Dovetails* tab or here). Please note that certain imaging modalities will require additional optics to alter the properties of the beam; these optics may be easily incorporated in the optical path via lens tubes and cage systems. In addition, Thorlabs offers condensers, which reshape input collimated light to help create optimal Köhler illumination. These attach to a mounting arm, which holds the condenser at the throat depth, or the distance from the optical path to the support rail. The arm attaches to a focusing module, used for aligning the condenser with respect to the sample and trans-illumination module.



Sample Viewing/Recording

Once illuminated, examining a sample with a microscope requires both focusing on the sample plane (see blue components to the right) and visualizing the resulting image (see pink components).

A microscope objective collects and magnifies light from the sample plane for imaging. On the Cerna microscope, the objective is threaded onto a nosepiece, which holds the objective at the throat depth, or the distance from the optical path to the support rail of the microscope body. This nosepiece is secured to a motorized focusing module, used for focusing the objective as well as for moving it out of the way for sample handling. To ensure a light-tight path from the objective, the microscope body comes with a bellows (not pictured).

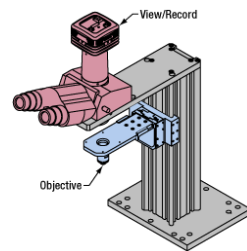

Enlarge
Light from the sample plane is collected through an objective (blue) and viewed using trinocs or other optical ports (pink).

Click to

Various modules are available for sample viewing and data collection. Trinoculars have three points of vision to view the sample directly as well as with a camera. Double camera ports redirect or split the optical path among two viewing channels. Camera tubes increase or decrease the image magnification. For data collection, Thorlabs offers both cameras and photomultiplier tubes (PMTs), the latter being necessary to detect fluorescence signals for confocal microscopy. Breadboard tops provide functionality for custom-designed data collection setups. Modules are attached to the microscope body via a circular dovetail (see the *Microscope Dovetails* tab or here for details).

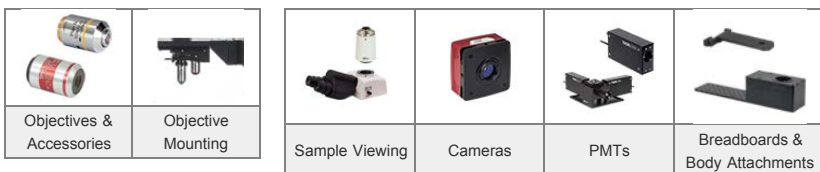

Sample/Experiment Mounting

Various sample and equipment mounting options are available to take advantage of the large working space of this microscope system. Large samples and ancillary equipment can be mounted via mounting platforms, which fit around the microscope body and utilize a breadboard design with regularly spaced tapped through holes. Small samples can be mounted on rigid stands (for example, see the purple component to the right), which have holders for different methods of sample preparation and data collection, such as slides, well plates, and petri dishes. For more traditional sample mounting, slides can also be mounted directly onto the microscope body via a manual XY stage. The rigid stands can translate by way of motorized stages (sold separately), while the mounting platforms contain built-in mechanics for motorized or manual translation. Rigid stands can also be mounted on top of the mounting platforms for independent and synchronized movement of multiple instruments, if you are interested in performing experiments simultaneously during microscopy.

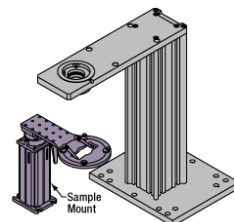

Click to Enlarge
The rigid stand (purple) pictured is one of various sample mounting options available.

Close

				
Translating Platforms	Rigid Stands	Translation Stages for Rigid Stands	Motorized XY Stages	Manual XY Stage

For sample viewing, Thorlabs offers trinoculars, double camera ports, and camera tubes. Light from the sample plane can be collected via cameras, photomultiplier tubes (PMTs), or custom setups using breadboard tops. Click here for additional information about viewing samples with a Cerna microscope.

Product Families & Web Presentations

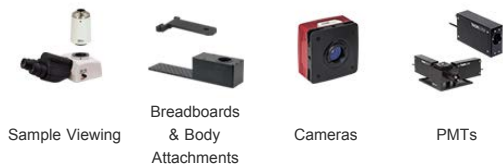

Sample Viewing

Breadboards & Body Attachments

Cameras

PMTs

Close

Microscope objectives are held in the optical path of the microscope via a nosepiece. Click here for additional information about viewing a sample with a Cerna microscope.

Product Families & Web Presentations



Objectives

Objective Thread Adapters

Parfocal Length Extender

Piezo Objective Scanner

Objective Mounting

Close

Large and small experiment mounting options are available to take advantage of the large working space of this microscope. Click here for additional information about mounting a sample for microscopy.

Product Families & Web Presentations



Translating Platforms

Rigid Stands

Translation Stages for Rigid Stands

Motorized XY Stages

Manual XY Stage

Close

Thorlabs offers various light sources for epi- and trans-illumination. Please see the full web presentation of each to determine its functionality within the Cerna microscopy platform.

Product Families & Web Presentations



Trans-Illumination Kits Solis™ High-Power LEDs Mounted LEDs X-Cite® Lamps Other Light Sources

Close

Epi-illumination illuminates the sample on the same side as the viewing apparatus. Example imaging modalities include fluorescence, confocal, and reflected light microscopy. Click here for additional information on epi-illumination with Cerna.

Product Families & Web Presentations



Epi-Illumination

Body Attachments

Light Sources

Close

Trans-illumination illuminates from the opposite side of the sample as the viewing apparatus. Example imaging modalities include brightfield, differential interference contrast (DIC), Dotd gradient contrast, oblique, and darkfield microscopy. Click here for additional information on trans-illumination with Cerna.

Product Families & Web Presentations

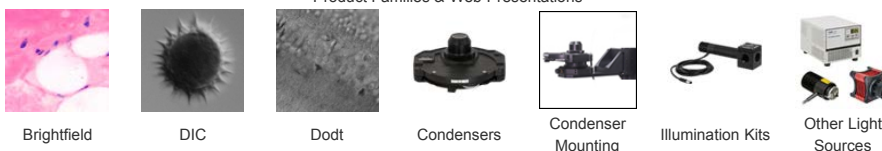

Brightfield

DIC

Dotd

Condensers

Condenser Mounting

Illumination Kits

Other Light Sources

Close

The microscope body provides the foundation of any Cerna microscope. The 7.74" throat depth provides a large working space for experiments. Click here for additional information about the Cerna microscope body.

Product Families & Web Presentations



Microscope Bodies

Microscope Translator

[Hide Preconfigured Cerna™ Microscope](#)

Preconfigured Cerna™ Microscope

The CM1001 Cerna™ Microscope includes all components shown in the *Shipping List* tab.

Part Number	Description	Price	Availability
CM1001	Cerna Microscope with Single-Cube Epi-Illuminator	\$10,398.92	Lead Time

[Hide Cerna™ Microscope Components for Customized Configurations](#)

Cerna™ Microscope Components for Customized Configurations

To tailor the CM1001 Cerna™ microscope to your imaging needs, its components can be added all at once to the shopping cart using the "Add Kit" button at the bottom of the ordering area, or individually using the shopping cart icon next to each item. Items may be removed from the default item list by changing the value in the "Qty" box to 0 before clicking the "Add Kit" button. This allows our modular microscope components to be used to adapt the microscope to the needs of the particular experiment. A discount is offered when a sufficient number of components are purchased, as reflected in the price of the CM1001. Please see the *Shipping List* tab for additional information about each component in the CM1001 microscope.

Part Number	Description	Price	Availability
CEA1350	Cerna Microscope Body with Epi-Illumination Arm, 350 mm Rail	\$828.00	Today
WFA4000	Trinoculars with 10X Eyepieces, Inverted Image, IR Filter	\$2,915.00	Today
WFA4105	1X Camera Tube with C-Mount, Male D2N Dovetail	\$395.00	Today
WFA2001	Epi-Illuminator Module for 1 Cube, Conditioning Optics, Male & Female D1N Dovetails	\$1,699.00	Today
CSA1100	Nosepiece for 1 Objective, M32 x 0.75 Threads, 60 mm Cage Compatible	\$174.00	Today
ZFM2020	Motorized Module with 1" Travel for Edge-Mounted Arms	\$1,726.00	Lead Time

MCM3001	Three-Channel Controller and Knob Box for 1" Cerna Travel Stages	\$3,113.00	3-5 Days
----------------	-------------------------------------------------------------------------	-------------------	-----------------

Visit the *Cerna™ Microscope with Single-Cube Epi-Illuminator* page for pricing and availability information:
https://www.thorlabs.com/newgrouppage9.cfm?objectgroup_id=8841