

CM1-G01 - Nov. 23, 2016

Item # CM1-G01 was discontinued on Nov. 23, 2016. For informational purposes, this is a copy of the website content at that time and is valid only for the stated product.

30 MM CAGE CUBE-MOUNTED TURNING PRISM MIRRORS

- ▶ Metallic- or Dielectric-Coated Turning Prism Mirrors
- ▶ Premounted in 30 mm Cage Cubes
- ▶ Compatible with SM1 Lens Tubes and 30 mm Cage System



CM1-G01

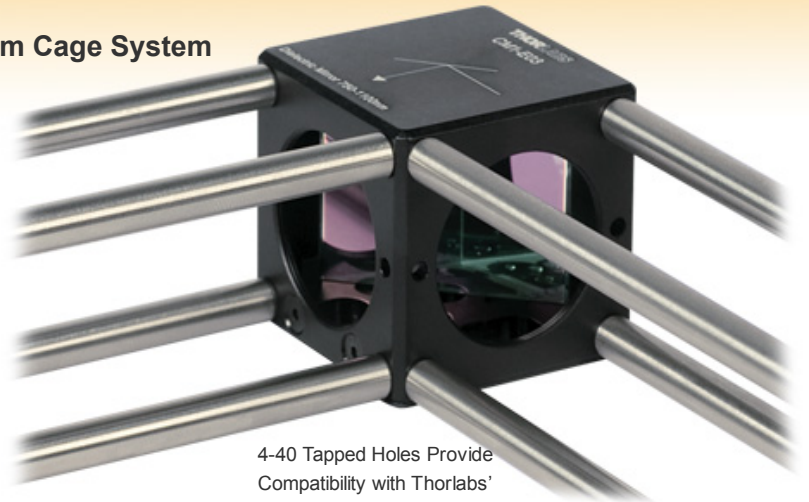

4-40 Tapped Holes Provide Compatibility with Thorlabs' 30 mm Cage System, Rods

Features

- Choose from Seven Coating Options
 - Metallic: UV-Enhanced Aluminum, Protected Aluminum, Protected Silver, Protected Gold
 - Dielectric: E02 (450 - 750 nm), E03 (750 - 1100 nm), or K13 Nd:YAG (532 nm and 1064 nm)
- Compatible with Our SM1 Lens Tubes and 30 mm Cage System
- Part Number and Coating are Engraved on the Housing for Easy Identification
- Post Mountable

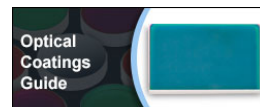

Click to Enlarge
Two Mirrors Can be Connected Using ERSCA adapters and 30 mm Cage Rods



Click to Enlarge
CM1-M01 with SM1 Lens Tubes Mounted to the Entrance and Exit Ports

These Cage Cube-Mounted Turning Mirrors provide additional flexibility when building optical devices from our 30 mm cage system and SM1 lens tube products. The mounted turning mirrors are prealigned so that the reflected beam exits to within ± 20 arcmin of 90° , which can reduce the time needed for aligning the mirror in a setup. For higher accuracy or more alignment flexibility, see our 90° turning mirror kinematic mounts. The turning mirrors are available with any of seven reflective coatings: UV-enhanced aluminum, protected aluminum, protected silver, protected gold, E02 broadband dielectric (400 - 750 nm), E03 broadband dielectric (750 - 1100 nm), or K13 Nd:YAG dielectric (532 nm and 1064 nm). A complete list of mirror specifications is provided on the *Specs* tab. Reflectance plots and data are provided on the *Graphs* tab.

A bottom-located M6 x 0.5 or M4 x 0.7 tap is included for post mounting. Cubes with M6 x 0.5 taps come with 8-32 and M4 adapters for imperial and metric post compatibility (the M6 x 0.5 tap is only compatible with the included adapters). The entrance and exit ports feature our SM1 (1.035"-40) threading for compatibility with Thorlabs' SM1 lens tubes (as seen in the photo to the right) and four 4-40 taps that accept our $\varnothing 6$ mm cage rods. The mounted turning mirrors can be connected to other cage cubes through the use of our cage rods and ERSCA adapters, as shown to the far right. Please note that two turning mirrors cannot be connected using the CM1-CC Cage Cube Connector (available below) due to a lack of $\varnothing 6$ mm cage rod holes on two sides of the cube. However, the CM1-CC can be used to attach the turning mirrors to other CM1 style cubes. Each mirror is epoxied within the cage cube and cannot be removed. However, empty 30 mm cage cubes are available below that are compatible with our line of unmounted Prism Mirrors. For a complete selection of our cube-mounted optics please see the *Mounted Optics Guide* tab.

Item #	CM1-F01 and CCM1-F01/M	CM1-G01 and CCM1-G01/M	CM1-P01 and CCM1-P01/M	CM1-M01 and CCM1-M01/M	CM1-E02 and CCM1-E02/M	CM1-E03 and CCM1-E03/M	CM1-K13 and CCM1-K13/M
Unmounted Prism Item #	MRA25-F01	MRA25-G01	MRA25-P01	MRA25-M01	MRA25-E02	MRA25-E03	MRA25-K13
Reflective Coating	UV-Enhanced Aluminum	Protected Aluminum	Protected Silver	Protected Gold	E02 Dielectric	E03 Dielectric	Nd:YAG Dielectric
Reflectance (Wavelength Range)	$R_{avg} > 90\%$ (250 - 450 nm)	$R_{avg} > 90\%$ (450 nm - 2 μm) $R_{avg} > 95\%$ (2 - 20 μm)	$R_{avg} > 97.5\%$ (450 nm - 2 μm) $R_{avg} > 96\%$ (2 - 20 μm)	$R_{avg} > 96\%$ (800 nm - 20 μm)	$R_{avg} > 99\%$ (400 - 750 nm)	$R_{avg} > 99\%$ (750 - 1100 nm)	R_s and R_p : >98% (532 nm) >99% (1064 nm)

Metallic-Coated Mirrors

Item #	CM1-F01 and CCM1-F01/M	CM1-G01 and CCM1-G01/M	CM1-P01 and CCM1-P01/M	CM1-M01 and CCM1-M01/M
Unmounted Prism Item #	MRA25-F01	MRA25-G01	MRA25-P01	MRA25-M01
Reflective Coating	UV-Enhanced Aluminum	Protected Aluminum	Protected Silver	Protected Gold
Reflectance (Wavelength Range)	$R_{avg} > 90\%$ (250 - 450 nm)	$R_{avg} > 90\%$ (450 nm - 2 μm) $R_{avg} > 95\%$ (2 - 20 μm)	$R_{avg} > 97.5\%$ (450 nm - 2 μm) $R_{avg} > 96\%$ (2 - 20 μm)	$R_{avg} > 96\%$ (800 nm - 20 μm)
Damage Threshold with 10 ns pulse, 10 Hz	0.3 J/cm ² (355 nm, \emptyset 0.381 mm)	0.3 J/cm ² (1064 nm, \emptyset 1.000 mm)	3 J/cm ² (1064 nm, \emptyset 1.000 mm)	2 J/cm ² (1064 nm, \emptyset 1.000 mm)
CW Damage Threshold ^a	300 W/cm (1.064 μm , \emptyset 0.044 mm) 500 W/cm (10.6 μm , \emptyset 0.339 mm)	60 W/cm (1.064 μm , \emptyset 0.044 mm) 350 W/cm (10.6 μm , \emptyset 0.339 mm)	1750 W/cm (1.064 μm , \emptyset 0.044 mm) 1500 W/cm (10.6 μm , \emptyset 0.339 mm)	1500 W/cm (1.064 μm , \emptyset 0.044 mm) 750 W/cm (10.6 μm , \emptyset 0.339 mm)
Ports	2 Ports, Each with SM1 (1.035"-40) Threading and Four 4-40 Taps for Cage Rods			
Post Mounting	M6 x 0.5 Tapped Hole with 8-32 and M4 x 0.7 Adapters (for Item #s Starting with CM1) M4 x 0.7 Tapped Hole (for Item #s Starting with CCM1)			
Mirror Substrate	N-BK7			
Material-Housing	Engraved Black Anodized Aluminum Housing			
Surface Flatness (@633 nm)	$< \lambda/10$ (Over Clear Aperture)			
Clear Aperture	$> \emptyset 17.5$ mm			
Surface Quality	40-20 Scratch-Dig			
Beam Path Deviation	$90^\circ \pm 20$ arcmin			

- a. The power density of your beam should be calculated in terms of W/cm. For an explanation of why the linear power density provides the best metric for long pulse and CW sources, please see the *Damage Thresholds* tab.

Dielectric-Coated Mirrors

Item #	CM1-E02 and CCM1-E02/M	CM1-E03 and CCM1-E03/M	CM1-K13 and CCM1-K13/M
Unmounted Prism Item #	MRA25-E02	MRA25-E03	MRA25-K13
Reflective Coating	E02 Dielectric	E03 Dielectric	Nd:YAG Dielectric
Reflectance (Wavelength Range)	$R_{avg} > 99\%$ (400 - 750 nm)	$R_{avg} > 99\%$ (750 - 1100 nm)	R_s and R_p : >98% (532 nm) >99% (1064 nm)
Damage Threshold with 10 ns pulse, 10 Hz	0.25 J/cm ² (532 nm, \emptyset 0.803 mm)	1.0 J/cm ² (810 nm, \emptyset 0.133 mm) 0.5 J/cm ² (1064 nm, \emptyset 0.433 mm)	8 J/cm ² (532 nm, \emptyset 0.491 mm) 5 J/cm ² (1064 nm, \emptyset 1.010 mm)
Ports	2 Ports, Each with SM1 (1.035"-40) Threading and Four 4-40 Taps for Cage Rods		
Post Mounting	M6 x 0.5 Tapped Hole with 8-32 and M4 x 0.7 Adapters (for Item #s Starting with CM1) M4 x 0.7 Tapped Hole (for Item #s Starting with CCM1)		
Mirror Substrate	N-BK7		
Material-Housing	Engraved Black Anodized Aluminum Housing		
Surface Flatness (@633 nm)	$< \lambda/10$ (Over Clear Aperture)		
Clear Aperture	$> \emptyset 17.5$ mm		
Surface Quality	10-5 Scratch-Dig		
Beam Path Deviation	$90^\circ \pm 20$ arcmin		

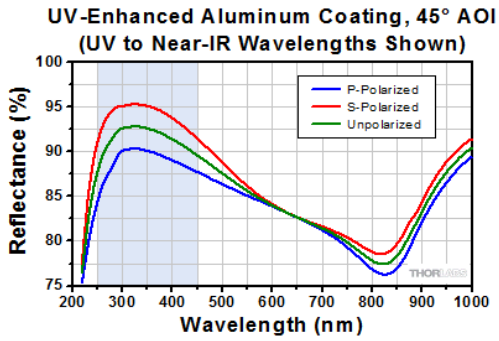

Click to Enlarge

Excel Spreadsheet with Raw Data for UV-Enhanced Aluminum, 12° and 45° AOI

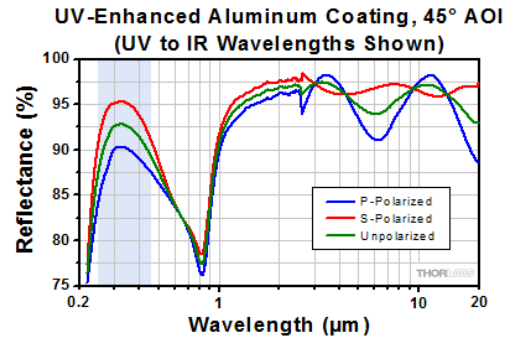

Click to Enlarge

Excel Spreadsheet with Raw Data for UV-Enhanced Aluminum, 12° and 45° AOI

Protected Aluminum Coating (450 nm - 20 μm)

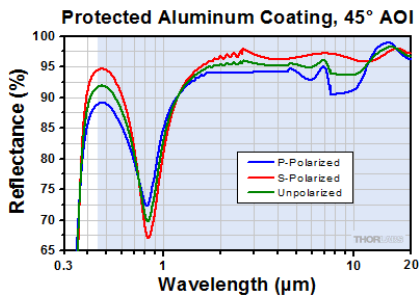

Click to Enlarge

Excel Spreadsheet with Raw Data for Protected Aluminum, 12° and 45° AOI

Protected Silver Coating (450 nm - 20 μm)

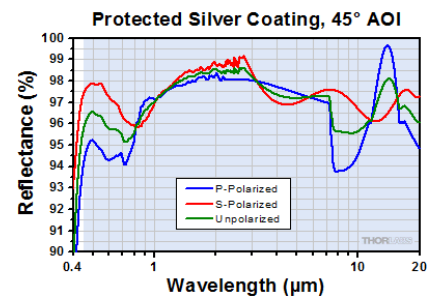

Click to Enlarge

Excel Spreadsheet with Raw Data for Protected Silver, 12° and 45° AOI

Protected Gold Coating (800 nm - 20 μm)

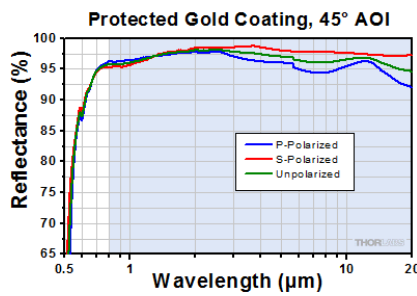

Excel Spreadsheet with Raw Data for Protected Silver, 12° and 45° AOI

These plots show the reflectance of our -E02 (400 - 750 nm) and -E03 (750 - 1100 nm) dielectric coatings for a typical coating run. The shaded region in each graph denotes the spectral range over which the coating is highly reflective. Due to variations in each run, this recommended spectral range is narrower than the actual range over which the optic will be highly reflective. If you have any concerns about the interpretation of this data, please contact Tech Support. For applications that require a mirror that bridges the spectral range between the dielectric coatings, please consider a metallic mirror.

-E02 Coating (400 - 750 nm)

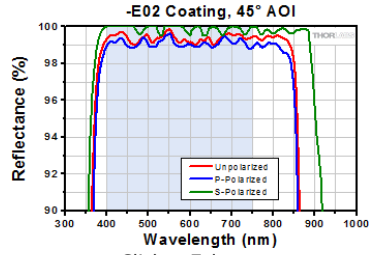

Click to Enlarge

Excel Spreadsheet with Raw Data for -E02 Coating, 8° and 45° AOI

-E03 Coating (750 - 1100 nm)

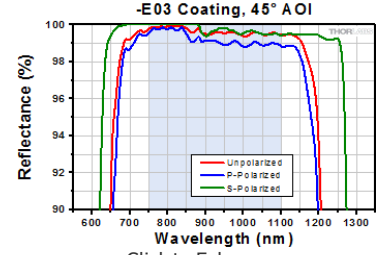

Click to Enlarge

Excel Spreadsheet with Raw Data for -E03 Coating, 8° and 45° AOI

-K13 Coating (532 nm and 1064 nm)

These plots show the reflectance of our Nd:YAG (532 nm and 1064 nm) dielectric coating for a typical coating run. Although there will be variations in the broadband reflectance from run to run, this optic is guaranteed to meet the reflectance specification at 532 nm and 1064 nm (see the table on the *Overview* tab). If you have any concerns about the interpretation of this data, please contact Tech Support.

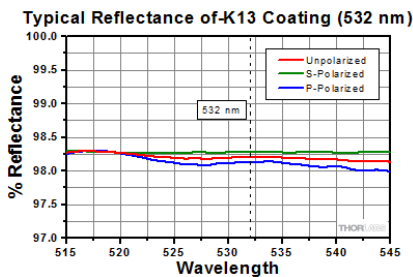

Click to Enlarge



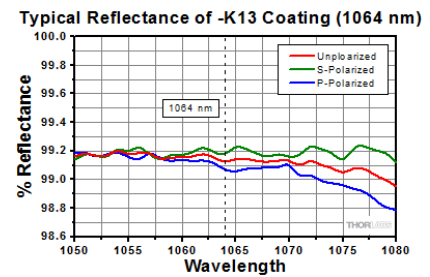

Excel Spreadsheet with Raw Data for Dielectric Nd:YAG Laser Line Coating, 8° (Unpolarized) and 45° (S- and P-Polarized) AOI

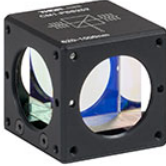

Click to Enlarge

30 mm Cage-Cube-Mounted Optics Selection Guide

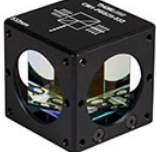
The table below provides links to all of our 30 mm Cage-Cube-Mounted optics. For our selection of 16 mm Cage-Cube-Mounted Optics, please see our 16 mm Cage Systems guide.

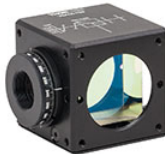
		
Non-Polarizing Beamsplitter Cube	Polarizing Beamsplitter Cube	High-Power Polarizing Beamsplitter Cube
		
Pellicle Beamsplitters	Laser Line Polarizing Beamsplitter Cube	Circular / Variable Polarizers
		
Penta Prisms	Turning Mirrors	Variable Beamsplitters / Attenuators

30 mm Cage Cube Empty Optic Mounts Selection Guide

	
Rectangular Dichroic Mirrors and Filters	Empty Compact 30 mm Cage Cube

Damage Threshold Data for Thorlabs' Turning Mirrors

The specifications to the right are measured data for Thorlabs' turning mirrors.

Damage Threshold Specifications		
Item #	Type	Damage Threshold
CM1-F01 and CCM1-F01/M	Pulse	0.3 J/cm ² (355 nm, 10 ns, 10 Hz, Ø0.381 mm)
	CW ^a	300 W/cm (1.064 µm, Ø0.044 mm) 500 W/cm (10.6 µm, Ø0.339 mm)
CM1-G01 and CCM1-G01/M	Pulse	0.3 J/cm ² (1064 nm, 10 ns, 10 Hz, Ø1.000 mm)
	CW ^a	60 W/cm (1.064 µm, Ø0.044 mm) 350 W/cm (10.6 µm, Ø0.339 mm)
CM1-P01 and CCM1-P01/M	Pulse	3 J/cm ² (1064 nm, 10 ns, 10 Hz, Ø1.000 mm)
	CW ^a	1750 W/cm (1.064 µm, Ø0.044 mm) 1500 W/cm (10.6 µm, Ø0.339 mm)
CM1-M01 and CCM1-M01/M	Pulse	2 J/cm ² (1064 nm, 10 ns, 10 Hz, Ø1.000 mm)
	CW ^a	1500 W/cm (1.064 µm, Ø0.044 mm) 750 W/cm (10.6 µm, Ø0.339 mm)
CM1-E02 and CCM1-E02/M	Pulse	0.25 J/cm ² (532 nm, 10 ns, 10 Hz, Ø0.803 mm)
CM1-E03 and CCM1-E03/M	Pulse	1.0 J/cm ² (810 nm, 10 ns, 10 Hz, Ø0.133 mm)
		0.5 J/cm ² (1064 nm, 10 ns, 10 Hz, Ø0.433 mm)
CM1-K13 and CCM1-K13/M	Pulse	8 J/cm ² (532 nm, 10 ns, 10 Hz, Ø0.491 mm)
		5 J/cm ² (1064 nm, 10 ns, 10 Hz, Ø1.010 mm)

- The power density of your beam should be calculated in terms of W/cm. For an explanation of why the linear power density provides the best metric for long pulse and CW sources, please see the "Continuous Wave and Long-Pulse Lasers" section below.

Laser Induced Damage Threshold Tutorial

The following is a general overview of how laser induced damage thresholds are measured and how the values may be utilized in determining the appropriateness of an optic for a given application. When choosing optics, it is important to understand the Laser Induced Damage Threshold (LIDT) of the optics being used. The LIDT for an optic greatly depends on the type of laser you are using. Continuous wave (CW) lasers typically cause damage from thermal effects (absorption either in the coating or in the substrate). Pulsed lasers, on the other hand, often strip electrons from the lattice structure of an optic before causing thermal damage. Note that the guideline presented here assumes room temperature operation and optics in new condition (i.e., within scratch-dig spec, surface free of contamination, etc.). Because dust or other particles on the surface of an optic can cause damage at lower thresholds, we recommend keeping surfaces clean and free of debris. For more information on cleaning optics, please see our *Optics Cleaning* tutorial.

Testing Method

Thorlabs' LIDT testing is done in compliance with ISO/DIS11254 specifications. A standard 1-on-1 testing regime is performed to test the damage threshold.

First, a low-power/energy beam is directed to the optic under test. The optic is exposed in 10 locations to this laser beam for a set duration of time (CW) or number of pulses (pulse repetition frequency specified). After exposure, the optic is examined by a microscope (~100X magnification) for any visible damage. The number of locations that are damaged at a particular power/energy level is recorded. Next, the power/energy is either increased or decreased and the optic is exposed at 10 new locations. This process is repeated until damage is observed. The damage threshold is then assigned to be the highest power/energy that the optic can withstand without causing damage. A histogram such as that below represents the testing of one BB1-E02 mirror.



The photograph above is a protected aluminum-

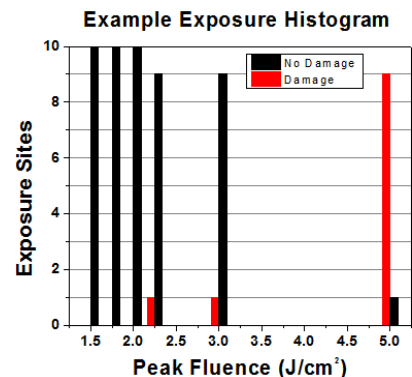

coated mirror after LIDT testing. In this particular test, it handled 0.43 J/cm² (1064 nm, 10 ns pulse, 10 Hz, Ø1.000 mm) before damage.

According to the test, the damage threshold of the mirror was 2.00 J/cm² (532 nm, 10 ns pulse, 10 Hz, Ø0.803 mm). Please keep in mind that these tests are performed on clean optics, as dirt and contamination can significantly lower the damage threshold of a component. While the test results are only representative of one coating run, Thorlabs specifies damage threshold values that account for coating variances.

Continuous Wave and Long-Pulse Lasers

When an optic is damaged by a continuous wave (CW) laser, it is usually due to the melting of the surface as a result of absorbing the laser's energy or damage to the optical coating (antireflection) [1]. Pulsed lasers with pulse lengths longer than 1 μs can be treated as CW lasers for LIDT discussions. Additionally, when pulse lengths are between 1 ns and 1 μs, LIDT can occur either because of absorption or a dielectric breakdown (must check both CW and pulsed LIDT). Absorption is either due to an intrinsic property of the optic or due to surface irregularities; thus LIDT values are only valid for optics meeting or exceeding the surface quality specifications given by a manufacturer. While many optics can handle high power CW lasers, cemented (e.g., achromatic doublets) or highly absorptive (e.g., ND filters) optics tend to have lower CW damage thresholds. These lower thresholds are due to absorption or scattering in the cement or metal coating.

Pulsed lasers with high pulse repetition frequencies (PRF) may behave similarly to CW beams. Unfortunately, this is highly dependent on factors such as absorption and thermal diffusivity, so there is no reliable method for determining when a high PRF laser will damage an optic due to thermal effects. For beams with a large PRF both the average and peak powers must be compared to the equivalent CW power. Additionally, for highly transparent materials, there is little to no drop in the LIDT with increasing PRF.

In order to use the specified CW damage threshold of an optic, it is necessary to know the following:

1. Wavelength of your laser
2. Linear power density of your beam (total power divided by 1/e² beam diameter)
3. Beam diameter of your beam (1/e²)
4. Approximate intensity profile of your beam (e.g., Gaussian)

The power density of your beam should be calculated in terms of W/cm. The graph to the right shows why expressing the LIDT as a linear power density provides the best metric for long pulse and CW sources. In this regime, the LIDT given as a linear power density can be applied to any beam diameter; one does not need to compute an adjusted LIDT to adjust for changes in spot size. This calculation assumes a uniform beam intensity profile. You must now consider hotspots in the beam or other non-uniform intensity profiles and roughly calculate a maximum power density. For reference, a Gaussian beam typically has a maximum power density that is twice that of the uniform beam (see lower right).

Now compare the maximum power density to that which is specified as the LIDT for the optic. If the optic was tested at a wavelength other than your operating wavelength, the damage threshold must be scaled appropriately. A good rule of thumb is that the damage threshold has a linear relationship with wavelength such that as you move to shorter wavelengths, the damage threshold decreases (i.e., a LIDT of 10 W/cm at 1310 nm scales to 5 W/cm at 655 nm):

$$\text{Adjusted LIDT} = \text{LIDT Power} \left(\frac{\text{Your Wavelength}}{\text{LIDT Wavelength}} \right)$$

While this rule of thumb provides a general trend, it is not a quantitative analysis of LIDT vs wavelength. In CW applications, for instance, damage scales more strongly with absorption in the coating and substrate, which does not necessarily scale well with wavelength. While the above procedure provides a good rule of thumb for LIDT values, please contact Tech Support if your wavelength is different from the specified LIDT wavelength. If your power density is less than the adjusted LIDT of the optic, then the optic should work for your application.

Please note that we have a buffer built in between the specified damage thresholds online and the tests which we have done, which accommodates variation between batches. Upon request, we can provide individual test information and a testing certificate. The damage analysis will be carried out on a similar optic (customer's optic will not be damaged). Testing may result in additional costs or lead times. Contact Tech Support for more information.

Pulsed Lasers

Example Test Data			
Fluence	# of Tested Locations	Locations with Damage	Locations Without Damage
1.50 J/cm ²	10	0	10
1.75 J/cm ²	10	0	10
2.00 J/cm ²	10	0	10
2.25 J/cm ²	10	1	9
3.00 J/cm ²	10	1	9
5.00 J/cm ²	10	9	1

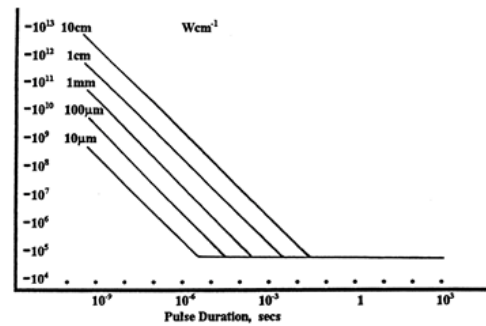

LIDT in linear power density vs. pulse length and spot size. For long pulses to CW, linear power density becomes a constant with spot size. This graph was obtained from [1].

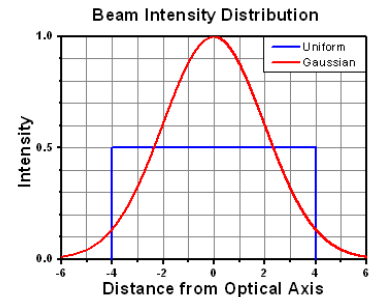

As previously stated, pulsed lasers typically induce a different type of damage to the optic than CW lasers. Pulsed lasers often do not heat the optic enough to damage it; instead, pulsed lasers produce strong electric fields capable of inducing dielectric breakdown in the material. Unfortunately, it can be very difficult to compare the LIDT specification of an optic to your laser. There are multiple regimes in which a pulsed laser can damage an optic and this is based on the laser's pulse length. The highlighted columns in the table below outline the relevant pulse lengths for our specified LIDT values.

Pulses shorter than 10^{-9} s cannot be compared to our specified LIDT values with much reliability. In this ultra-short-pulse regime various mechanics, such as multiphoton-avalanche ionization, take over as the predominate damage mechanism [2]. In contrast, pulses between 10^{-7} s and 10^{-4} s may cause damage to an optic either because of dielectric breakdown or thermal effects. This means that both CW and pulsed damage thresholds must be compared to the laser beam to determine whether the optic is suitable for your application.

Pulse Duration	$t < 10^{-9}$ s	$10^{-9} < t < 10^{-7}$ s	$10^{-7} < t < 10^{-4}$ s	$t > 10^{-4}$ s
Damage Mechanism	Avalanche Ionization	Dielectric Breakdown	Dielectric Breakdown or Thermal	Thermal
Relevant Damage Specification	N/A	Pulsed	Pulsed and CW	CW

When comparing an LIDT specified for a pulsed laser to your laser, it is essential to know the following:

1. Wavelength of your laser
2. Energy density of your beam (total energy divided by $1/e^2$ area)
3. Pulse length of your laser
4. Pulse repetition frequency (prf) of your laser
5. Beam diameter of your laser ($1/e^2$)
6. Approximate intensity profile of your beam (e.g., Gaussian)

The energy density of your beam should be calculated in terms of J/cm^2 . The graph to the right shows why expressing the LIDT as an energy density provides the best metric for short pulse sources. In this regime, the LIDT given as an energy density can be applied to any beam diameter; one does not need to compute an adjusted LIDT to adjust for changes in spot size. This calculation assumes a uniform beam intensity profile. You must now adjust this energy density to account for hotspots or other nonuniform intensity profiles and roughly calculate a maximum energy density. For reference a Gaussian beam typically has a maximum energy density that is twice that of the $1/e^2$ beam.

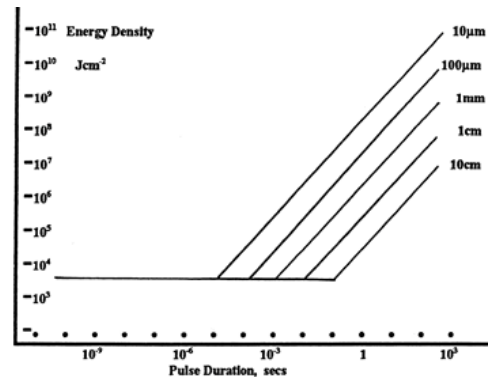

LIDT in energy density vs. pulse length and spot size. For short pulses, energy density becomes a constant with spot size. This graph was obtained from [1].

Now compare the maximum energy density to that which is specified as the LIDT for the optic. If the optic was tested at a wavelength other than your operating wavelength, the damage threshold must be scaled appropriately [3]. A good rule of thumb is that the damage threshold has an inverse square root relationship with wavelength such that as you move to shorter wavelengths, the damage threshold decreases (i.e., a LIDT of 1 J/cm^2 at 1064 nm scales to 0.7 J/cm^2 at 532 nm):

$$\text{Adjusted LIDT} = \text{LIDT Energy} \sqrt{\frac{\text{Your Wavelength}}{\text{LIDT Wavelength}}}$$

You now have a wavelength-adjusted energy density, which you will use in the following step.

Beam diameter is also important to know when comparing damage thresholds. While the LIDT, when expressed in units of J/cm^2 , scales independently of spot size; large beam sizes are more likely to illuminate a larger number of defects which can lead to greater variances in the LIDT [4]. For data presented here, a <1 mm beam size was used to measure the LIDT. For beams sizes greater than 5 mm, the LIDT (J/cm^2) will not scale independently of beam diameter due to the larger size beam exposing more defects.

The pulse length must now be compensated for. The longer the pulse duration, the more energy the optic can handle. For pulse widths between 1 - 100 ns, an approximation is as follows:

$$\text{Adjusted LIDT} = \text{LIDT Energy} \sqrt{\frac{\text{Your Pulse Length}}{\text{LIDT Pulse Length}}}$$

Use this formula to calculate the Adjusted LIDT for an optic based on your pulse length. If your maximum energy density is less than this adjusted LIDT maximum energy density, then the optic should be suitable for your application. Keep in mind that this calculation is only used for pulses between 10^{-9} s and 10^{-7} s. For pulses between 10^{-7} s and 10^{-4} s, the CW LIDT must also be checked before deeming the optic appropriate for your application.

Please note that we have a buffer built in between the specified damage thresholds online and the tests which we have done, which accommodates variation between batches. Upon request, we can provide individual test information and a testing certificate. Contact Tech Support for more information.

[1] R. M. Wood, *Optics and Laser Tech.* **29**, 517 (1997).

[2] Roger M. Wood, *Laser-Induced Damage of Optical Materials* (Institute of Physics Publishing, Philadelphia, PA, 2003).

[3] C. W. Carr *et al.*, *Phys. Rev. Lett.* **91**, 127402 (2003).

[4] N. Bloembergen, *Appl. Opt.* **12**, 661 (1973).

In order to illustrate the process of determining whether a given laser system will damage an optic, a number of example calculations of laser induced damage threshold are given below. For assistance with performing similar calculations, we provide a spreadsheet calculator that can be downloaded by clicking the button to the right. To use the calculator, enter the specified LIDT value of the optic under consideration and the relevant parameters of your laser system in the green boxes. The spreadsheet will then calculate a linear power density for CW and pulsed systems, as well as an energy density value for pulsed systems. These values are used to calculate adjusted, scaled LIDT values for the optics based on accepted scaling laws. This calculator assumes a Gaussian beam profile, so a correction factor must be introduced for other beam shapes (uniform, etc.). The LIDT scaling laws are determined from empirical relationships; their accuracy is not guaranteed. Remember that absorption by optics or coatings can significantly reduce LIDT in some spectral regions. These LIDT values are not valid for ultrashort pulses less than one nanosecond in duration.

[LIDT Calculator](#)

CW Laser Example

Suppose that a CW laser system at 1319 nm produces a 0.5 W Gaussian beam that has a $1/e^2$ diameter of 10 mm. A naive calculation of the average linear power density of this beam would yield a value of 0.5 W/cm, given by the total power divided by the beam diameter:

$$\text{Linear Power Density} = \frac{\text{Power}}{\text{Beam Diameter}}$$

However, the maximum power density of a Gaussian beam is about twice the maximum power density of a uniform beam, as shown in the graph to the right. Therefore, a more accurate determination of the maximum linear power density of the system is 1 W/cm.

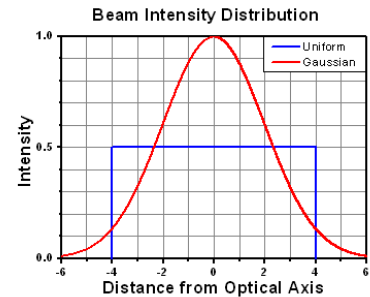

A Gaussian beam profile has about twice the maximum intensity of a uniform beam profile.

An AC127-030-C achromatic doublet lens has a specified CW LIDT of 350 W/cm, as tested at 1550 nm. CW damage threshold values typically scale directly with the wavelength of the laser source, so this yields an adjusted LIDT value:

$$\text{Adjusted LIDT} = \text{LIDT Power} \left(\frac{\text{Your Wavelength}}{\text{LIDT Wavelength}} \right)$$

The adjusted LIDT value of 350 W/cm \times (1319 nm / 1550 nm) = 298 W/cm is significantly higher than the calculated maximum linear power density of the laser system, so it would be safe to use this doublet lens for this application.

Pulsed Nanosecond Laser Example: Scaling for Different Pulse Durations

Suppose that a pulsed Nd:YAG laser system is frequency tripled to produce a 10 Hz output, consisting of 2 ns output pulses at 355 nm, each with 1 J of energy, in a Gaussian beam with a 1.9 cm beam diameter ($1/e^2$). The average energy density of each pulse is found by dividing the pulse energy by the beam area:

$$\text{Energy Density} = \frac{\text{Pulse Energy}}{\text{Beam Area}}$$

As described above, the maximum energy density of a Gaussian beam is about twice the average energy density. So, the maximum energy density of this beam is $\sim 0.7 \text{ J/cm}^2$.

The energy density of the beam can be compared to the LIDT values of 1 J/cm² and 3.5 J/cm² for a BB1-E01 broadband dielectric mirror and an NB1-K08 Nd:YAG laser line mirror, respectively. Both of these LIDT values, while measured at 355 nm, were determined with a 10 ns pulsed laser at 10 Hz. Therefore, an adjustment must be applied for the shorter pulse duration of the system under consideration. As described on the previous tab, LIDT values in the nanosecond pulse regime scale with the square root of the laser pulse duration:

$$\text{Adjusted LIDT} = \text{LIDT Energy} \sqrt{\frac{\text{Your Pulse Length}}{\text{LIDT Pulse Length}}}$$

This adjustment factor results in LIDT values of 0.45 J/cm² for the BB1-E01 broadband mirror and 1.6 J/cm² for the Nd:YAG laser line mirror, which are to be compared with the 0.7 J/cm² maximum energy density of the beam. While the broadband mirror would likely be damaged by the laser, the more specialized laser line mirror is appropriate for use with this system.

Pulsed Nanosecond Laser Example: Scaling for Different Wavelengths

Suppose that a pulsed laser system emits 10 ns pulses at 2.5 Hz, each with 100 mJ of energy at 1064 nm in a 16 mm diameter beam ($1/e^2$) that must be

attenuated with a neutral density filter. For a Gaussian output, these specifications result in a maximum energy density of 0.1 J/cm². The damage threshold of an NDUV10A Ø25 mm, OD 1.0, reflective neutral density filter is 0.05 J/cm² for 10 ns pulses at 355 nm, while the damage threshold of the similar NE10A absorptive filter is 10 J/cm² for 10 ns pulses at 532 nm. As described on the previous tab, the LIDT value of an optic scales with the square root of the wavelength in the nanosecond pulse regime:

$$\text{Adjusted LIDT} = \text{LIDT Energy} \sqrt{\frac{\text{Your Wavelength}}{\text{LIDT Wavelength}}}$$

This scaling gives adjusted LIDT values of 0.08 J/cm² for the reflective filter and 14 J/cm² for the absorptive filter. In this case, the absorptive filter is the best choice in order to avoid optical damage.









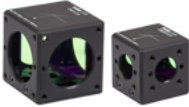

Pulsed Microsecond Laser Example

Consider a laser system that produces 1 µs pulses, each containing 150 µJ of energy at a repetition rate of 50 kHz, resulting in a relatively high duty cycle of 5%. This system falls somewhere between the regimes of CW and pulsed laser induced damage, and could potentially damage an optic by mechanisms associated with either regime. As a result, both CW and pulsed LIDT values must be compared to the properties of the laser system to ensure safe operation.

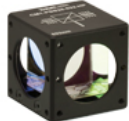
If this relatively long-pulse laser emits a Gaussian 12.7 mm diameter beam (1/e²) at 980 nm, then the resulting output has a linear power density of 5.9 W/cm and an energy density of 1.2 x 10⁻⁴ J/cm² per pulse. This can be compared to the LIDT values for a WPQ10E-980 polymer zero-order quarter-wave plate, which are 5 W/cm for CW radiation at 810 nm and 5 J/cm² for a 10 ns pulse at 810 nm. As before, the CW LIDT of the optic scales linearly with the laser wavelength, resulting in an adjusted CW value of 6 W/cm at 980 nm. On the other hand, the pulsed LIDT scales with the square root of the laser wavelength and the square root of the pulse duration, resulting in an adjusted value of 55 J/cm² for a 1 µs pulse at 980 nm. The pulsed LIDT of the optic is significantly greater than the energy density of the laser pulse, so individual pulses will not damage the wave plate. However, the large average linear power density of the laser system may cause thermal damage to the optic, much like a high-power CW beam.

ND:YAG OPTICS

Thorlabs offers a wide selection of optics optimized for use with Nd:YAG lasers. Please see below for more information.

Nd:YAG Optics Selection				
Dielectric Mirrors			Beamsplitters	
				
Laser Line Mirrors, 1064 nm, 532 nm, 355 nm, 266 nm	Right-Angle Prism Mirrors, 1064 nm, 532 nm	Cage Cube-Mounted Prism Mirrors, 1064 nm, 532 nm	Harmonic Beamsplitters, 1064 nm, 532 nm, 355 nm, 266 nm	High-Power Polarizing Beamsplitter Cubes, 1064 nm, 532 nm: Unmounted or Mounted
Lenses		Objectives	Filters	
				
UVFS Plano-Convex Lenses, 1064 nm, 532 nm: Unmounted or Mounted	Air-Spaced Doublets, 1064 nm, 532 nm	High Power Focusing Objectives, 1064 nm, 532 nm	Laser Line Filters, 1064 nm: Standard or Premium	Laser Line Filters, 532 nm: Standard or Premium

30 mm Cage Cube-Mounted Turning Prism Mirrors

Part Number	Description	Price	Availability
CCM1-F01/M	Customer Inspired!30 mm Cage Cube-Mounted UV-Enhanced Aluminum Turning Mirror, M4 Tap	\$169.00	Today
CCM1-G01/M	Customer Inspired!30 mm Cage Cube-Mounted Protected Aluminum Turning Mirror, M4 Tap	\$169.00	Today
CCM1-P01/M	Customer Inspired!30 mm Cage Cube-Mounted Protected Silver Turning Mirror, M4 Tap	\$161.00	Today
CCM1-M01/M	Customer Inspired!30 mm Cage Cube-Mounted Protected Gold Turning Mirror, M4 Tap	\$169.00	Today
CCM1-E02/M	Customer Inspired!30 mm Cage Cube-Mounted E02 Dielectric Turning Mirror, 400-750 nm, M4 Tap	\$220.00	Today
CCM1-E03/M	Customer Inspired!30 mm Cage Cube-Mounted E03 Dielectric Turning Mirror, 750-1100 nm, M4 Tap	\$224.00	Today
CCM1-K13/M	Customer Inspired!30 mm Cage-Cube-Mounted Nd:YAG Turning Mirror, 532 and 1064 nm, M4 Tap	\$285.00	Today
CM1-F01	30 mm Cage Cube-Mounted UV-Enhanced Aluminum Turning Mirror	\$173.00	Today
CM1-G01	30 mm Cage Cube-Mounted Protected Aluminum Turning Mirror	\$173.00	Today
CM1-P01	30 mm Cage Cube-Mounted Protected Silver Turning Mirror	\$166.00	Today
CM1-M01	30 mm Cage Cube-Mounted Protected Gold Turning Mirror	\$173.00	Today
CM1-E02	30 mm Cage Cube-Mounted E02 Dielectric Turning Mirror, 400-750 nm	\$226.00	Today
CM1-E03	30 mm Cage Cube-Mounted E03 Dielectric Turning Mirror, 750-1100 nm	\$231.00	Today
CM1-K13	30 mm Cage-Cube-Mounted Nd:YAG Turning Mirror, 532 and 1064 nm	\$294.00	Today

Cage Cube Connector

- ▶ Connect Two 1.5" Wide Cage Cubes Side by Side
- ▶ Compatible with CM1 and CCM1 Series Cage Cubes

The CM1-CC cube connector allows two or more cubes to be connected as shown in the image to the right. Many of our cage cubes are compatible with this connector, including empty cubes, empty dichroic cubes, mounted beamsplitters, mounted penta prisms, and mounted turning mirrors.

Two cage cube-mounted turning mirrors cannot be connected using the CM1-CC due to a lack of Ø6 mm cage rod holes on two sides of the cube.

Alignment Pins

Please note that because dowel alignment pins are used, the connector requires drilled holes on the cube face between the SM1-threaded (1.035"-40) ports. If you have an older cube and would like it updated to have alignment holes for free, please contact Technical Support. Alternatively, the alignment pins are press-fit inside their mounting holes, and can be pressed out for use with cubes that do not have these alignment holes.



Click to Enlarge
Two CM1-CC Connectors
used to Connect Multiple 1.5"
Wide Cage Cubes

Part Number	Description	Price	Availability
CM1-CC	Cage Cube Connector for Compact 30 mm Cage Cubes	\$44.10	Today

Compact 30 mm Cage Cube for Prisms and Beamsplitter Cubes

- ▶ Compatible with 30 mm Cage System and SM1 Lens Tubes
- ▶ Directly Accepts 1" Cubes and 25 mm Right-Angle Prisms
- ▶ Mounting Adapters Available for Thorlabs' Beamsplitter Cubes Smaller than 25 mm
- ▶ Four SM1-Threaded Ports
- ▶ Base is Post Mountable via 8-32 (M4) Tap
- ▶ 3 Prism Alignment Stops Provide Accuracy of ± 20 arcmin



Click to Enlarge
CCM1-4ER with Penta Prism (Optic Sold Separately)

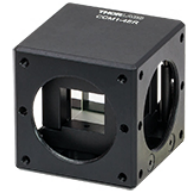

Click to Enlarge
BS127CAM Beamsplitter
Cube Adapter Mounted in
the CCM1-4ER Cage Cube
(Optic and Adapter Sold Separately)

These 1.5" wide cage cubes directly accept a 1" or 25 mm square optic, such as a beamsplitter cube or right-angle prism, with adapters available here for mounting a 5 mm (0.20"), 10 mm (0.39"), 12.7 mm (0.50"), or 20 mm (0.79") beamsplitter cube. The base of the cube has an 8-32 (M4) tap to attach to $\varnothing 1/2$ " Posts. Shown to the far right is a 12.7 mm (0.50") beamsplitter cube being mounted in the CCM1-4ER using the BS127CAM Beamsplitter Cube Adapter. Two cage cubes can be connected using ER rods and ERSCA Cage Rod Adapters.

The optic is clamped within the cube by tightening three 1.5 mm hex screws of a tension plate (see image to the right), allowing the user to replace the optic with any other compatible optic when necessary. The optic must sit flush against the three corners of the cube base. Do not overtighten the tension plate, this could damage the optic. The image to the right shows a penta prism mounted in a CCM1-4ER with the outer housing removed.

Part Number	Description	Price	Availability
CCM1-4ER/M	Customer Inspired! Compact Clamping 4-Port Prism/Mirror 30 mm Cage Cube, M4 Tap	\$128.00	Today
CCM1-4ER	NEW! Customer Inspired! Compact Clamping 4-Port Prism/Mirror 30 mm Cage Cube, 8-32 Tap	\$128.00	Today