

CM1-BS014 - Sept. 27, 2016

Item # CM1-BS014 was discontinued on Sept. 27, 2016. For informational purposes, this is a copy of the website content at that time and is valid only for the stated product.

NON-POLARIZING BEAMSPLITTER CUBES IN 30 MM CAGE CUBES

- ▶ 50:50 Split Ratio
- ▶ SM1 and 30 mm Cage System Compatible
- ▶ AR-Coated Cube Faces

Application Idea



Cage Setup with KC1 Kinematic Mirror Mounts, a Non-Polarizing Beamsplitter Cube, and 30 mm Cage Plates

[Hide Overview](#)

OVERVIEW

Features

- 30 mm Cage System and SM1 Lens Tube Compatible Mounts
- Wavelength Ranges from 400 nm to 1600 nm

Thorlabs offers three types of mounted beamsplitters: Polarization-Insensitive Beamsplitting Cubes (presented below), Polarizing Beamsplitting Cubes, and the Pellicle Beamsplitters. A large variety of unmounted beamsplitters are also available.

For a direct comparison of the performance of our non-polarizing beamsplitter cube, plate, and pellicle at 633 nm, see the *Lab Facts* tab.

The dielectric beamsplitter coating is applied to the hypotenuse of one of the two prisms that make up the cube. Then, cement is used to bind the two prism halves together. In order to achieve the desired 50:50 split ratio, the light must enter through one of the entrance faces of the beamsplitter-coated prism, as indicated in the diagram to the right. Each beamsplitter cube is epoxied within the cage cube mount and cannot be removed from the mount. We also offer empty 30 mm cage cubes that are compatible with our line of unmounted beamsplitter cubes and right-angle prisms.

For a complete selection of our cube-mounted optics please see the *Mounted Optics Guide* tab.

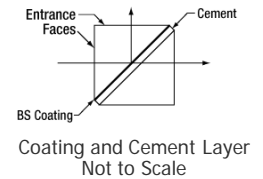

[Hide Specs](#)

SPECS

| Item # | CM1-BS013 and CCM1-BS013/M | CM1-BS014 and CCM1-BS014/M | CM1-BS015 and CCM1-BS015/M |
|--------------------------------|----------------------------|----------------------------|----------------------------|
| AR-Coating Range | 400 - 700 nm | 700 - 1100 nm | 1100 - 1600 nm |
| AR Coating (0° Incident Angle) | $R_{avg} < 0.5\%$ | $R_{avg} < 0.5\%$ | $R_{avg} < 0.5\%$ |

| | | | | |
|---|--|---|---|--|
| Split Ratio | 50:50 | | | |
| Ports | 4 Ports With SM1 (1.035"-40) Thread | | | |
| Beamsplitter Material | N-BK7 - Grade A | | | |
| Housing Material | Engraved Black Anodized Aluminum Housing | | | |
| Surface Flatness | $\lambda/10$ at 633 nm | | | |
| Max Transmitted Beam Deviation ^a | <5 arcmin | | | |
| Reflected Beam Deviation ^b | $90^\circ \pm 20$ arcmin | | | |
| Clear Aperture | $\varnothing 20.3$ mm | | | |
| Surface Quality | 40-20 Scratch-Dig | | | |
| Damage Threshold | Pulsed | 0.25 J/cm ² (532 nm, 10 ns, 10 Hz, $\varnothing 0.341$ mm) | 0.25 J/cm ² (810 nm, 10 ns, 10 Hz, $\varnothing 0.166$ mm) | 0.25 J/cm ² (1542 nm, 10 ns, 10 Hz, $\varnothing 0.282$ mm) |
| | CW ^c | 300 W/cm (532 nm, $\varnothing 0.042$ mm) | - | - |

- a. Defined with respect to the non-polarizing beamsplitter cube, not the mechanical housing.
- b. Defined with respect to the mechanical housing.
- c. The power density of your beam should be calculated in terms of W/cm. For an explanation of why the linear power density provides the best metric for long pulse and CW sources, please see the *Damage Thresholds* tab.

[Hide Lab Facts](#)

LAB FACTS

Thorlabs Lab Fact: Beamsplitter Package Matters

We present laboratory measurements of the polarization angle, split ratio, and total throughput power of a beam transmitted through Thorlabs plate, cube, and pellicle beamsplitters. While all non-polarizing beamsplitters function similarly, the exact performance is different for different types of beamsplitter. Each type of beamsplitter contains its own advantages and disadvantages compared to other types of beamsplitters. Appropriate choice of beamsplitter is essential to sensitive experimental systems. We present a complete analysis and comparison of optical parameters for three common types of non-polarizing beamsplitters.

For our experiment we used the former generation HRS015 stabilized HeNe laser (replaced by the HRS015B) as the light source for our investigation. A linear polarizer is used to set the laser beam's polarization axis to 45° in order to provide equal S- and P-polarized light incident on the beamsplitter. The beamsplitter under investigation was then placed in the beampath, and its split beams directed to appropriate detectors. The total power through the optic, polarization states, split ratios, and angle of incidence effects were investigated under this configuration.

Lab Facts

Click for full Lab Facts summary

The plots below summarize the measured results for all three types of beamsplitters. From these graphs the performance of each optic can be easily compared to one another. The bottom left plot summarizes the results for the total power throughput for each optic. The total power throughput is measured as the fraction of input power. While the plate and pellicle beamsplitters perform rather similarly, the cube shows signs of absorption inside the optic. Additionally, this plot shows the relative insensitivity of throughput power to angle of incidence. The bottom middle graph summarizes the results for the output polarization angle for each optic. The cube shows the most similar polarization angles between the reflected and transmitted beams, with the plate producing the largest difference in polarization between beams. The bottom right plot summarizes the results for the split ratio, as a fraction of input power, for the beamsplitters. Here it can be shown that the plate beamsplitter demonstrates the most ideal for 50/50 power splitting. For details on the experimental setup employed and the results summarized here, please click here.

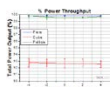

Click to Enlarge

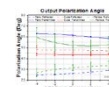

Click to Enlarge

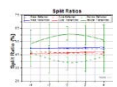

Click to Enlarge

[Hide BS Selection Guide](#)

BS SELECTION GUIDE

Beamsplitter Selection Guide

Legend for Beam Diagrams

Thorlabs offers five main types of beamsplitters: Pellicle, Cube, Plate, Economy, and Polka Dot. Each type has distinct advantages and disadvantages.

Reflected Beam:  Transmitted Beam: 

Pellicle Beamsplitters - Pellicle beamsplitters are the best choice when dispersion must be kept to a minimum. They virtually eliminate multiple reflections commonly associated with thicker glass beamsplitters, thus preventing ghosting. In addition, unlike plate beamsplitters, there is a negligible effect on the propagation axis of the transmitted beam with respect to the incident beam.

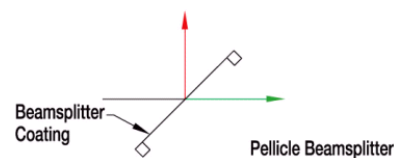

Pellicle beamsplitters have two disadvantages: They exhibit sinusoidal oscillations in the splitting ratio as a function of wavelength, due to thin film interference effects. Click Here for more details. They are also extremely delicate. Since they are fabricated by stretching a nitrocellulose membrane over a flat metal frame, the beamsplitter cannot be touched without destroying the optic. Thorlabs offers pellicle beamsplitters mounted in metal rings for use in kinematic mounts as well as 30 mm cage cube-mounted pellicles.

Beamsplitting Cubes

Thorlabs' beamsplitter cubes are composed of two right-angled prisms. A dielectric coating, which is capable of reflecting and transmitting a portion of the incident beam, is applied to the hypotenuse surface. Since there is only one reflecting surface, this design inherently avoids ghost images, which sometimes occur with plate-type beamsplitters. Antireflection coatings are available on the entrance and exit faces of certain models to minimize back reflections. As well as providing a cost-effective solution, another advantage of the beamsplitting cube is the minimal shift it causes to the path of the transmitted beam. Thorlabs offers both polarizing and nonpolarizing beamsplitting cubes, in mounted and unmounted configurations. Mounted beamsplitters are available that are compatible with our 16 mm cage systems as well as our 30 mm cage systems.

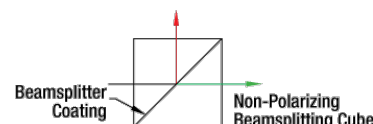
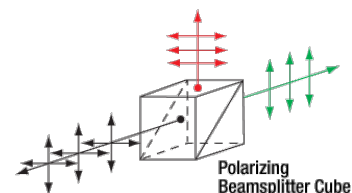

Polarizing Beamsplitters - Thorlabs' polarizing plate and cube beamsplitters split randomly polarized beams into two orthogonal, linearly polarized components (S and P), as shown in the diagram to the right. S-polarized light is reflected at a 90° angle with respect to the incident beam while p-polarized light is transmitted. Polarizing beamsplitters are useful in applications where the two polarization components are to be analyzed or used simultaneously. Thorlabs offers broadband 16 mm cage cube-mounted, broadband 30 mm cage cube-mounted, and broadband unmounted polarizing beamsplitter cubes, as well as laser line 30 mm cage cube-mounted and laser line unmounted cubes. Additionally, Thorlabs offers wire grid polarizing beamsplitters which have a larger Angle of Incidence and work with uncollimated light. For applications requiring higher power, we also offer high-power polarizing beamsplitting cubes.

Non-Polarizing Beamsplitting Cubes - These cubes provide a 50:50 splitting ratio that is nearly independent of the polarization of the incident light. The low polarization dependence of the metallic-dielectric coating allows the transmission and reflection for s- and p-polarization states to be within 10% or 15% of each other. These beamsplitters are particularly useful with randomly polarized lasers and are specifically designed for applications in which polarization effects must be minimized. Thorlabs offers 16 mm cage cube-mounted, 30 mm cage cube-mounted, and unmounted beamsplitter cubes.

Plate Beamsplitters - Thorlabs' plate beamsplitters are optimized for an incidence angle of 45° and feature a dielectric coating on the front surface for long-term stability. To help reduce unwanted interference effects (e.g., ghost images) caused by the interaction of light reflected from the front and back surfaces of the optic, a wedge has been added to the round versions of these beamsplitters. Dispersion, ghosting, and shifting of the beam may all be potential problems, however. These are the best choice for a general-purpose beamsplitter. Thorlabs offers both polarizing and nonpolarizing plate beamsplitters.

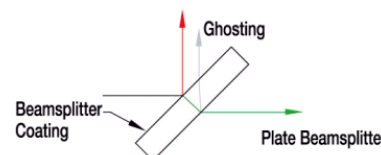

Economy Beamsplitters - These are the most cost effective of all the beamsplitter types. Thorlabs' economy beamsplitters, which have an exposed oxide coating on one side and are uncoated on the other side, are designed to have either a 50:50 or 30:70 splitting ratio throughout the visible spectrum (450 - 650 nm) when used with unpolarized light incident at 45°.

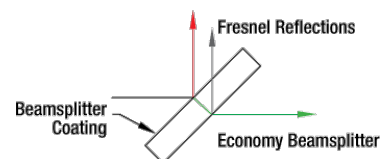

Please note that the Fresnel reflections off of the uncoated back surface of these economy beamsplitters can lead to interference effects in the reflected beam. For applications sensitive to these effects, consider using a beamsplitting cube or a pellicle beamsplitter.

Polka Dot Beamsplitters - This type of beamsplitter consists of a glass substrate with a vacuum-deposited reflective coating that is applied over an array of apertures, giving the beamsplitter a "polka dot" appearance. Half of the incident beam is reflected from the coating, and half of the beam is transmitted through the uncoated portion of the substrate.

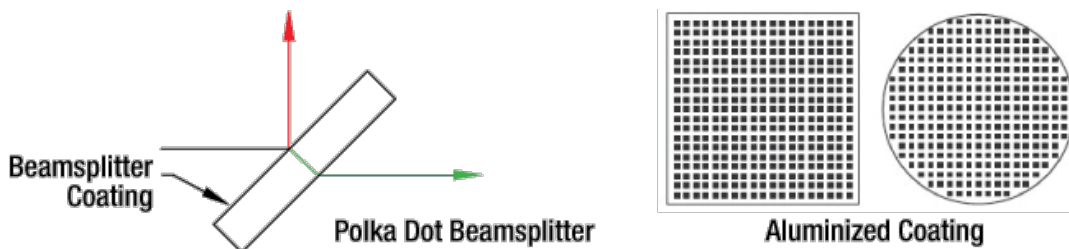

Polka dot beamsplitters are useful over a wide wavelength range and are negligibly angle sensitive, which makes them ideal for splitting the energy emitted from a radiant source. These are not recommended for imaging applications, such as interferometry, as the polka dot pattern will affect the image.

[Hide Mounted Optics Guide](#)

MOUNTED OPTICS GUIDE

30 mm Cage-Cube-Mounted Optics Selection Guide

The table below provides links to all of our 30 mm Cage-Cube-Mounted optics. For our selection of 16 mm Cage-Cube-Mounted Optics, please see our 16 mm Cage Systems guide.

| | | |
|---|---|---|
|  |  |  |
| Non-Polarizing Beamsplitter Cube | Polarizing Beamsplitter Cube | High-Power Polarizing Beamsplitter Cube |
|  |  |  |
| Pellicle Beamsplitters | Laser Line Polarizing Beamsplitter Cube | Circular / Variable Polarizers |
|  |  |  |
| Penta Prisms | Turning Mirrors | Variable Beamsplitters / Attenuators |

30 mm Cage Cube Empty Optic Mounts Selection Guide

| | |
|---|--|
|  |  |
| Rectangular Dichroic Mirrors and Filters | Empty Compact 30 mm Cage Cube |

[Hide Damage Thresholds](#)

DAMAGE THRESHOLDS

Damage Threshold Data for Thorlabs'

Damage Threshold Specifications

Non-Polarizing Cube Beamsplitters

The specifications to the right are measured data for Thorlabs' non-polarizing cube beamsplitters with a wavelength range from 400 to 700 nm. Damage threshold specifications are constant for all cubes, regardless of the size of the beamsplitter.

| Item # | Laser Type | Damage Threshold |
|-----------|-----------------|---|
| CM1-BS013 | Pulsed | 0.25 J/cm ² (532 nm, 10 ns, 10 Hz, Ø0.341 mm) |
| | CW ^a | 300 W/cm (532 nm, Ø0.042 mm) |
| CM1-BS014 | Pulsed | 0.25 J/cm ² (810 nm, 10 ns, 10 Hz, Ø0.166 mm) |
| CM1-BS015 | Pulsed | 0.25 J/cm ² (1542 nm, 10 ns, 10 Hz, Ø0.282 mm) |

- The power density of your beam should be calculated in terms of W/cm. For an explanation of why the linear power density provides the best metric for long pulse and CW sources, please see the "Continuous Wave and Long-Pulse Lasers" section below.

Laser Induced Damage Threshold Tutorial

The following is a general overview of how laser induced damage thresholds are measured and how the values may be utilized in determining the appropriateness of an optic for a given application. When choosing optics, it is important to understand the Laser Induced Damage Threshold (LIDT) of the optics being used. The LIDT for an optic greatly depends on the type of laser you are using. Continuous wave (CW) lasers typically cause damage from thermal effects (absorption either in the coating or in the substrate). Pulsed lasers, on the other hand, often strip electrons from the lattice structure of an optic before causing thermal damage. Note that the guideline presented here assumes room temperature operation and optics in new condition (i.e., within scratch-dig spec, surface free of contamination, etc.). Because dust or other particles on the surface of an optic can cause damage at lower thresholds, we recommend keeping surfaces clean and free of debris. For more information on cleaning optics, please see our *Optics Cleaning* tutorial.

Testing Method

Thorlabs' LIDT testing is done in compliance with ISO/DIS11254 specifications. A standard 1-on-1 testing regime is performed to test the damage threshold.

First, a low-power/energy beam is directed to the optic under test. The optic is exposed in 10 locations to this laser beam for a set duration of time (CW) or number of pulses (pulse repetition frequency specified). After exposure, the optic is examined by a microscope (~100X magnification) for any visible damage. The number of locations that are damaged at a particular power/energy level is recorded. Next, the power/energy is either increased or decreased and the optic is exposed at 10 new locations. This process is repeated until damage is observed. The damage threshold is then assigned to be the highest power/energy that the optic can withstand without causing damage. A histogram such as that below represents the testing of one BB1-E02 mirror.



The photograph above is a protected aluminum-coated mirror after LIDT testing. In this particular test, it handled 0.43 J/cm² (1064 nm, 10 ns pulse, 10 Hz, Ø1.000 mm) before damage.

According to the test, the damage threshold of the mirror was 2.00 J/cm² (532 nm, 10 ns pulse, 10 Hz, Ø0.803 mm). Please keep in mind that these tests are performed on clean optics, as dirt and contamination can significantly lower the damage threshold of a component. While the test results are only representative of one coating run, Thorlabs specifies damage threshold values that account for coating variances.

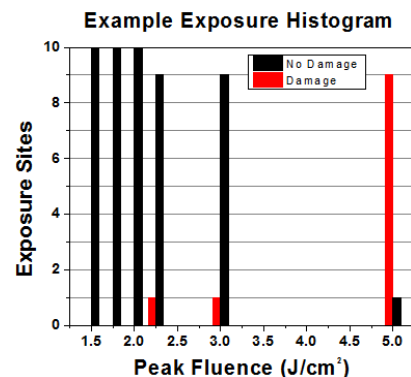

Example Test Data

| Fluence | # of Tested Locations | Locations with Damage | Locations Without Damage |
|------------------------|-----------------------|-----------------------|--------------------------|
| 1.50 J/cm ² | 10 | 0 | 10 |
| 1.75 J/cm ² | 10 | 0 | 10 |
| 2.00 J/cm ² | 10 | 0 | 10 |
| 2.25 J/cm ² | 10 | 1 | 9 |
| 3.00 J/cm ² | 10 | 1 | 9 |
| 5.00 J/cm ² | 10 | 9 | 1 |

Continuous Wave and Long-Pulse Lasers

When an optic is damaged by a continuous wave (CW) laser, it is usually due to the melting of the surface as a result of absorbing the laser's energy or damage to the optical coating (antireflection) [1]. Pulsed lasers with pulse lengths longer than 1 µs can be treated as CW lasers for LIDT discussions. Additionally, when pulse lengths are between 1 ns and 1 µs, LIDT can occur either because of absorption or a dielectric breakdown (must check both CW and pulsed LIDT). Absorption is either due to an intrinsic property of the optic or due to surface irregularities; thus LIDT values are only valid for optics meeting or exceeding the surface quality specifications given by a manufacturer. While many optics can handle high power CW lasers, cemented (e.g., achromatic doublets) or highly absorptive (e.g., ND filters) optics tend to have lower CW damage thresholds. These lower thresholds are due to absorption or scattering in the cement or metal coating.

Pulsed lasers with high pulse repetition frequencies (PRF) may behave similarly to CW beams. Unfortunately, this is highly dependent on factors such as absorption and thermal diffusivity, so there is no reliable method for determining when a high PRF laser will damage an optic due to thermal effects. For beams with a large PRF both the average and peak powers must be compared to the equivalent CW power. Additionally, for highly transparent materials, there is little to no drop in the LIDT with increasing PRF.

In order to use the specified CW damage threshold of an optic, it is necessary to know the following:

1. Wavelength of your laser
2. Linear power density of your beam (total power divided by $1/e^2$ beam diameter)
3. Beam diameter of your beam ($1/e^2$)
4. Approximate intensity profile of your beam (e.g., Gaussian)

The power density of your beam should be calculated in terms of W/cm. The graph to the right shows why expressing the LIDT as a linear power density provides the best metric for long pulse and CW sources. In this regime, the LIDT given as a linear power density can be applied to any beam diameter; one does not need to compute an adjusted LIDT to adjust for changes in spot size. This calculation assumes a uniform beam intensity profile. You must now consider hotspots in the beam or other non-uniform intensity profiles and roughly calculate a maximum power density. For reference, a Gaussian beam typically has a maximum power density that is twice that of the uniform beam (see lower right).

Now compare the maximum power density to that which is specified as the LIDT for the optic. If the optic was tested at a wavelength other than your operating wavelength, the damage threshold must be scaled appropriately. A good rule of thumb is that the damage threshold has a linear relationship with wavelength such that as you move to shorter wavelengths, the damage threshold decreases (i.e., a LIDT of 10 W/cm at 1310 nm scales to 5 W/cm at 655 nm):

$$\text{Adjusted LIDT} = \text{LIDT Power} \left(\frac{\text{Your Wavelength}}{\text{LIDT Wavelength}} \right)$$

While this rule of thumb provides a general trend, it is not a quantitative analysis of LIDT vs wavelength. In CW applications, for instance, damage scales more strongly with absorption in the coating and substrate, which does not necessarily scale well with wavelength. While the above procedure provides a good rule of thumb for LIDT values, please contact Tech Support if your wavelength is different from the specified LIDT wavelength. If your power density is less than the adjusted LIDT of the optic, then the optic should work for your application.

Please note that we have a buffer built in between the specified damage thresholds online and the tests which we have done, which accommodates variation between batches. Upon request, we can provide individual test information and a testing certificate. The damage analysis will be carried out on a similar optic (customer's optic will not be damaged). Testing may result in additional costs or lead times. Contact Tech Support for more information.

Pulsed Lasers

As previously stated, pulsed lasers typically induce a different type of damage to the optic than CW lasers. Pulsed lasers often do not heat the optic enough to damage it; instead, pulsed lasers produce strong electric fields capable of inducing dielectric breakdown in the material. Unfortunately, it can be very difficult to compare the LIDT specification of an optic to your laser. There are multiple regimes in which a pulsed laser can damage an optic and this is based on the laser's pulse length. The highlighted columns in the table below outline the relevant pulse lengths for our specified LIDT values.

Pulses shorter than 10^{-9} s cannot be compared to our specified LIDT values with much reliability. In this ultra-short-pulse regime various mechanics, such as multiphoton-avalanche ionization, take over as the predominate damage mechanism [2]. In contrast, pulses between 10^{-7} s and 10^{-4} s may cause damage to an optic either because of dielectric breakdown or thermal effects. This means that both CW and pulsed damage thresholds must be compared to the laser beam to determine whether the optic is suitable for your application.

| Pulse Duration | $t < 10^{-9}$ s | $10^{-9} < t < 10^{-7}$ s | $10^{-7} < t < 10^{-4}$ s | $t > 10^{-4}$ s |
|-------------------------------|----------------------|---------------------------|---------------------------------|-----------------|
| Damage Mechanism | Avalanche Ionization | Dielectric Breakdown | Dielectric Breakdown or Thermal | Thermal |
| Relevant Damage Specification | N/A | Pulsed | Pulsed and CW | CW |

When comparing an LIDT specified for a pulsed laser to your laser, it is essential to know the following:

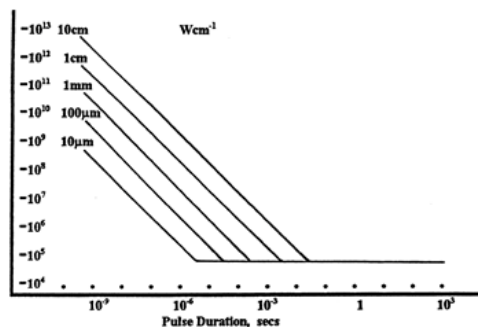

LIDT in linear power density vs. pulse length and spot size. For long pulses to CW, linear power density becomes a constant with spot size. This graph was obtained from [1].

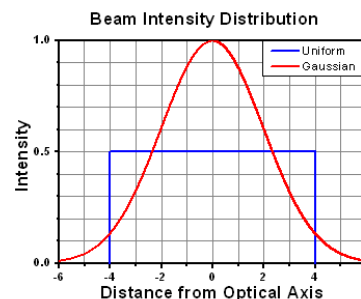

1. Wavelength of your laser
2. Energy density of your beam (total energy divided by $1/e^2$ area)
3. Pulse length of your laser
4. Pulse repetition frequency (prf) of your laser
5. Beam diameter of your laser ($1/e^2$)
6. Approximate intensity profile of your beam (e.g., Gaussian)

The energy density of your beam should be calculated in terms of J/cm^2 . The graph to the right shows why expressing the LIDT as an energy density provides the best metric for short pulse sources. In this regime, the LIDT given as an energy density can be applied to any beam diameter; one does not need to compute an adjusted LIDT to adjust for changes in spot size. This calculation assumes a uniform beam intensity profile. You must now adjust this energy density to account for hotspots or other nonuniform intensity profiles and roughly calculate a maximum energy density. For reference a Gaussian beam typically has a maximum energy density that is twice that of the $1/e^2$ beam.

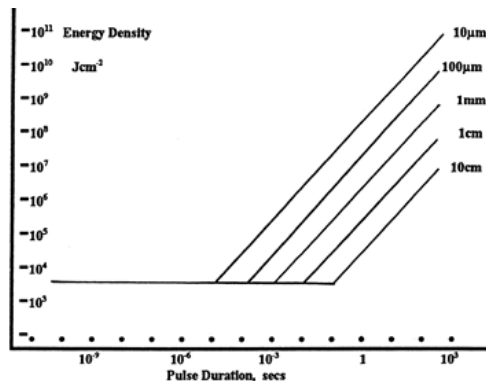

LIDT in energy density vs. pulse length and spot size. For short pulses, energy density becomes a constant with spot size. This graph was obtained from [1].

Now compare the maximum energy density to that which is specified as the LIDT for the optic. If the optic was tested at a wavelength other than your operating wavelength, the damage threshold must be scaled appropriately [3]. A good rule of thumb is that the damage threshold has an inverse square root relationship with wavelength such that as you move to shorter wavelengths, the damage threshold decreases (i.e., a LIDT of $1 J/cm^2$ at $1064 nm$ scales to $0.7 J/cm^2$ at $532 nm$):

$$\text{Adjusted LIDT} = \text{LIDT Energy} \sqrt{\frac{\text{Your Wavelength}}{\text{LIDT Wavelength}}}$$

You now have a wavelength-adjusted energy density, which you will use in the following step.

Beam diameter is also important to know when comparing damage thresholds. While the LIDT, when expressed in units of J/cm^2 , scales independently of spot size; large beam sizes are more likely to illuminate a larger number of defects which can lead to greater variances in the LIDT [4]. For data presented here, a $<1 mm$ beam size was used to measure the LIDT. For beams sizes greater than $5 mm$, the LIDT (J/cm^2) will not scale independently of beam diameter due to the larger size beam exposing more defects.

The pulse length must now be compensated for. The longer the pulse duration, the more energy the optic can handle. For pulse widths between $1 - 100 ns$, an approximation is as follows:

$$\text{Adjusted LIDT} = \text{LIDT Energy} \sqrt{\frac{\text{Your Pulse Length}}{\text{LIDT Pulse Length}}}$$

Use this formula to calculate the Adjusted LIDT for an optic based on your pulse length. If your maximum energy density is less than this adjusted LIDT maximum energy density, then the optic should be suitable for your application. Keep in mind that this calculation is only used for pulses between $10^{-9} s$ and $10^{-7} s$. For pulses between $10^{-7} s$ and $10^{-4} s$, the CW LIDT must also be checked before deeming the optic appropriate for your application.

Please note that we have a buffer built in between the specified damage thresholds online and the tests which we have done, which accommodates variation between batches. Upon request, we can provide individual test information and a testing certificate. Contact Tech Support for more information.

[1] R. M. Wood, Optics and Laser Tech. **29**, 517 (1997).

[2] Roger M. Wood, *Laser-Induced Damage of Optical Materials* (Institute of Physics Publishing, Philadelphia, PA, 2003).

[3] C. W. Carr *et al.*, Phys. Rev. Lett. **91**, 127402 (2003).

[4] N. Bloembergen, Appl. Opt. **12**, 661 (1973).

[Hide LIDT Calculations](#)

LIDT CALCULATIONS

In order to illustrate the process of determining whether a given laser system will damage an optic, a number of example calculations of laser induced damage threshold are given below. For assistance with performing similar calculations, we provide a spreadsheet calculator that can be downloaded by clicking the button to the right. To use the calculator, enter the specified LIDT value of the optic under consideration and the relevant parameters of your laser system in the green boxes. The spreadsheet will then calculate a linear power density for CW and pulsed systems, as well as an energy density value for pulsed systems. These values are used to calculate adjusted, scaled LIDT values for the optics based on accepted scaling laws. This calculator assumes a

[LIDT Calculator](#)

Gaussian beam profile, so a correction factor must be introduced for other beam shapes (uniform, etc.). The LIDT scaling laws are determined from empirical relationships; their accuracy is not guaranteed. Remember that absorption by optics or coatings can significantly reduce LIDT in some spectral regions. These LIDT values are not valid for ultrashort pulses less than one nanosecond in duration.

CW Laser Example

Suppose that a CW laser system at 1319 nm produces a 0.5 W Gaussian beam that has a $1/e^2$ diameter of 10 mm. A naive calculation of the average linear power density of this beam would yield a value of 0.5 W/cm, given by the total power divided by the beam diameter:

$$\text{Linear Power Density} = \frac{\text{Power}}{\text{Beam Diameter}}$$

However, the maximum power density of a Gaussian beam is about twice the maximum power density of a uniform beam, as shown in the graph to the right. Therefore, a more accurate determination of the maximum linear power density of the system is 1 W/cm.

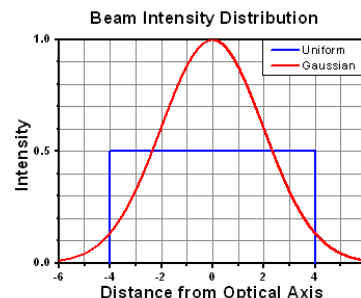

A Gaussian beam profile has about twice the maximum intensity of a uniform beam profile.

An AC127-030-C achromatic doublet lens has a specified CW LIDT of 350 W/cm, as tested at 1550 nm. CW damage threshold values typically scale directly with the wavelength of the laser source, so this yields an adjusted LIDT value:

$$\text{Adjusted LIDT} = \text{LIDT Power} \left(\frac{\text{Your Wavelength}}{\text{LIDT Wavelength}} \right)$$

The adjusted LIDT value of 350 W/cm x (1319 nm / 1550 nm) = 298 W/cm is significantly higher than the calculated maximum linear power density of the laser system, so it would be safe to use this doublet lens for this application.

Pulsed Nanosecond Laser Example: Scaling for Different Pulse Durations

Suppose that a pulsed Nd:YAG laser system is frequency tripled to produce a 10 Hz output, consisting of 2 ns output pulses at 355 nm, each with 1 J of energy, in a Gaussian beam with a 1.9 cm beam diameter ($1/e^2$). The average energy density of each pulse is found by dividing the pulse energy by the beam area:

$$\text{Energy Density} = \frac{\text{Pulse Energy}}{\text{Beam Area}}$$

As described above, the maximum energy density of a Gaussian beam is about twice the average energy density. So, the maximum energy density of this beam is $\sim 0.7 \text{ J/cm}^2$.

The energy density of the beam can be compared to the LIDT values of 1 J/cm² and 3.5 J/cm² for a BB1-E01 broadband dielectric mirror and an NB1-K08 Nd:YAG laser line mirror, respectively. Both of these LIDT values, while measured at 355 nm, were determined with a 10 ns pulsed laser at 10 Hz. Therefore, an adjustment must be applied for the shorter pulse duration of the system under consideration. As described on the previous tab, LIDT values in the nanosecond pulse regime scale with the square root of the laser pulse duration:

$$\text{Adjusted LIDT} = \text{LIDT Energy} \sqrt{\frac{\text{Your Pulse Length}}{\text{LIDT Pulse Length}}}$$

This adjustment factor results in LIDT values of 0.45 J/cm² for the BB1-E01 broadband mirror and 1.6 J/cm² for the Nd:YAG laser line mirror, which are to be compared with the 0.7 J/cm² maximum energy density of the beam. While the broadband mirror would likely be damaged by the laser, the more specialized laser line mirror is appropriate for use with this system.

Pulsed Nanosecond Laser Example: Scaling for Different Wavelengths

Suppose that a pulsed laser system emits 10 ns pulses at 2.5 Hz, each with 100 mJ of energy at 1064 nm in a 16 mm diameter beam ($1/e^2$) that must be attenuated with a neutral density filter. For a Gaussian output, these specifications result in a maximum energy density of 0.1 J/cm². The damage threshold of an NDUV10A Ø25 mm, OD 1.0, reflective neutral density filter is 0.05 J/cm² for 10 ns pulses at 355 nm, while the damage threshold of the similar NE10A absorptive filter is 10 J/cm² for 10 ns pulses at 532 nm. As described on the previous tab, the LIDT value of an optic scales with the square root of the wavelength in the nanosecond pulse regime:

$$\text{Adjusted LIDT} = \text{LIDT Energy} \sqrt{\frac{\text{Your Wavelength}}{\text{LIDT Wavelength}}}$$

This scaling gives adjusted LIDT values of 0.08 J/cm² for the reflective filter and 14 J/cm² for the absorptive filter. In this case, the absorptive filter is the best choice in order to avoid optical damage.

Pulsed Microsecond Laser Example

Consider a laser system that produces 1 μs pulses, each containing 150 μJ of energy at a repetition rate of 50 kHz, resulting in a relatively high duty cycle of 5%. This system falls somewhere between the regimes of CW and pulsed laser induced damage, and could potentially damage an optic by mechanisms associated with either regime. As a result, both CW and pulsed LIDT values must be compared to the properties of the laser system to ensure safe operation.







If this relatively long-pulse laser emits a Gaussian 12.7 mm diameter beam (1/e²) at 980 nm, then the resulting output has a linear power density of 5.9 W/cm and an energy density of 1.2 x 10⁻⁴ J/cm² per pulse. This can be compared to the LIDT values for a WPQ10E-980 polymer zero-order quarter-wave plate, which are 5 W/cm for CW radiation at 810 nm and 5 J/cm² for a 10 ns pulse at 810 nm. As before, the CW LIDT of the optic scales linearly with the laser wavelength, resulting in an adjusted CW value of 6 W/cm at 980 nm. On the other hand, the pulsed LIDT scales with the square root of the laser wavelength and the square root of the pulse duration, resulting in an adjusted value of 55 J/cm² for a 1 μs pulse at 980 nm. The pulsed LIDT of the optic is significantly greater than the energy density of the laser pulse, so individual pulses will not damage the wave plate. However, the large average linear power density of the laser system may cause thermal damage to the optic, much like a high-power CW beam.

[Hide Cube-Mounted, Non-Polarizing, 50:50 Beamsplitter Cubes](#)

Cube-Mounted, Non-Polarizing, 50:50 Beamsplitter Cubes

- ▶ 3 Models Covering the Wavelength Range of 400 to 1600 nm
- ▶ Split Ratio of 50:50
- ▶ Four SM1-Threaded Ports
- ▶ 4-40 Tapped Holes for 30 mm Cage

Each mounted non-polarizing beamsplitter cube incorporates one of our 1" (25.4 mm) non-polarizing beamsplitter cubes into a housing that has four SM1-threaded (1.035"-40) access ports and a set of tapped holes that accept our Ø6 mm cage rods. An antireflection coating is deposited on each face of the beamsplitter cube to minimize unwanted reflections (see the tabs above for specifications and typical performance plots). The bottom of each cube has an M6 x 0.5 or M4 tap, but adapters are included with the M6 x 0.5 tapped cubes for 8-32 or M4 mounting (the M6 x 0.5 tap is only compatible with the included adapters).

| Item # | Transmission | Reflectance |
|----------------------------|--|---|
| CM1-BS013 and CCM1-BS013/M |  Click Here for Raw Data |  |
| CM1-BS014 and CCM1-BS014/M |  Click Here for Raw Data |  |
| CM1-BS015 and CCM1-BS015/M |  Click Here for Raw Data |  |

| Part Number | Description | Price | Availability |
|--------------|---|----------|--------------|
| CCM1-BS013/M | Customer Inspired!30 mm Cage Cube-Mounted Non-Polarizing Beamsplitter, 400 - 700 nm, M4 Tap | \$268.00 | Today |
| CCM1-BS014/M | Customer Inspired!30 mm Cage Cube-Mounted Non-Polarizing Beamsplitter, 700 - 1100 nm, M4 Tap | \$278.00 | Today |
| CCM1-BS015/M | Customer Inspired!30 mm Cage Cube-Mounted Non-Polarizing Beamsplitter, 1100 - 1600 nm, M4 Tap | \$291.00 | Today |
| CM1-BS013 | 30 mm Cage Cube-Mounted Non-Polarizing Beamsplitter, 400 - 700 nm, 8-32 and M4 Adapters | \$276.00 | Lead Time |
| CM1-BS014 | 30 mm Cage Cube-Mounted Non-Polarizing Beamsplitter, 700 - 1100 nm, 8-32 and M4 Adapters | \$286.00 | Today |
| CM1-BS015 | 30 mm Cage Cube-Mounted Non-Polarizing Beamsplitter, 1100 - 1600 nm, 8-32 and M4 Adapters | \$300.00 | Lead Time |

[Hide Cage Cube Connector](#)

Cage Cube Connector

- ▶ Connect Two 1.5" Wide Cage Cubes Side by Side
- ▶ Compatible with CM1 and CCM1 Series Cage Cubes

The CM1-CC cube connector allows two or more CM1 or CCM1 cubes to be connected as shown in the image to the right. Many of our cage cubes are compatible with this connector, including empty cubes, empty dichroic cubes, mounted beamsplitters, mounted penta prisms, and mounted turning mirrors.

Two cage cube-mounted turning mirrors cannot be connected using the CM1-CC due to a lack of Ø6 mm cage rod holes on two sides of the cube.

Alignment Pins

Please note that because dowel alignment pins are used, the connector requires drilled holes on the cube face between the SM1-threaded (1.035"-40) ports. If you have an older cube and would like it updated to have alignment holes for free, please contact Technical Support. Alternatively, the alignment pins are press-fit inside their mounting holes, and can be pressed out for use with cubes that do not have these alignment holes.



Click to Enlarge
Two CM1-CC Connectors
used to Connect Multiple 1.5"
Wide Cage Cubes

| Part Number | Description | Price | Availability |
|-------------|--|---------|--------------|
| CM1-CC | Cage Cube Connector for Compact 30 mm Cage Cubes | \$44.10 | Today |

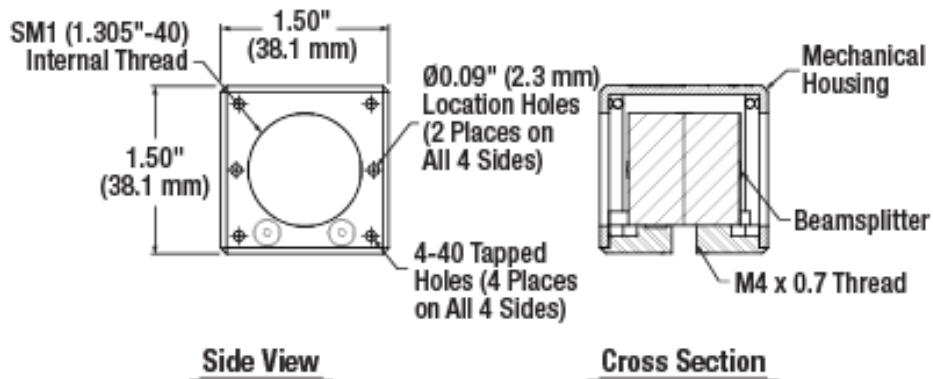
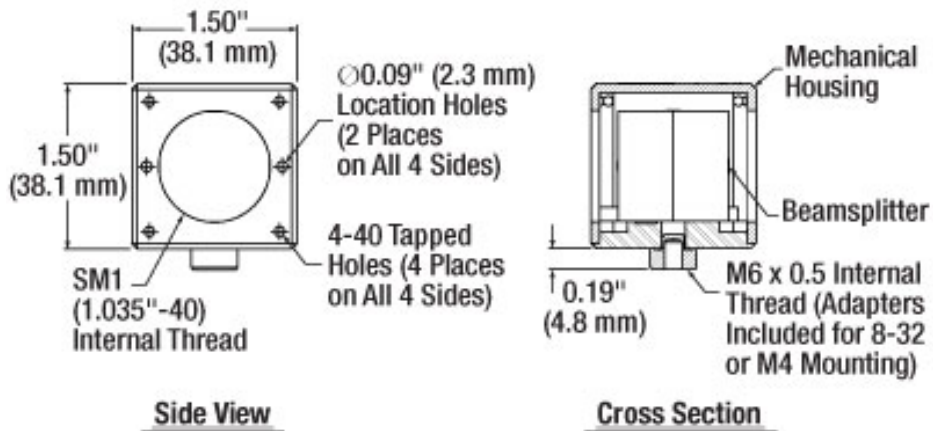

**50:50 Non-Polarizing Beamsplitter
700 - 1100 nm Coating**

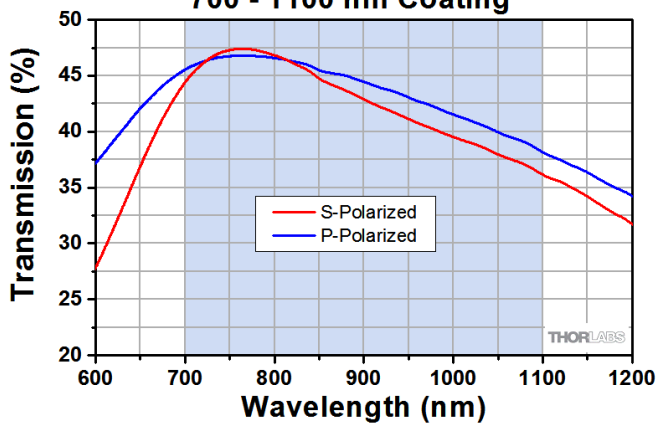

**Reflectance for 700 - 1100 nm
Non-Polarizing Beamsplitting Cube**

