

Laser Diode



L850P010



Description

Thorlabs Ø5.6 mm, TO-18 can package discreet laser diode is a compact light source suited to many applications. Our lasers are fully compatible with our entire line of Laser Diode and TEC Controllers as well as our selection of Laser Diode Mounts and Collimation Solutions.

Specifications

($P_o = 10 \text{ mW}$, $T_c = 25 \text{ }^\circ\text{C}$)

Specification	Symbol	Max
Optical Output Power, mW	P_o	10
LD Reverse Voltage, V	$V_{R(LD)}$	2
PD Reverse Voltage, V	$V_{R(PD)}$	30
Operation Case Temperature, $^\circ\text{C}$	T_{op}	-10 to 50
Storage Temperature, $^\circ\text{C}$	T_{STG}	-40 to 85

Specification	Symbol	Min	Typ	Max
Lasing Wavelength, nm	λ_p	835	850	865
Threshold Current, mA	I_{th}	10	25	40
Operation Current, mA	I_{op}	25	50	70
Operating Voltage, V	V_{op}	1.8	2.0	2.5
Monitor Current*, mA	I_m	0.05	0.3	1.0
Slope Efficiency, mW/mA	η	0.3	0.5	0.7
Beam Divergence, $^\circ$	$\theta_{//}$	8	10	12
Beam Divergence, $^\circ$	θ_{\perp}	25	30	40
Astigmatism**, μm	A_s		11	

*) $V_R = 5 \text{ V}$

***) $NA = 0.4$

Drawings



Top View

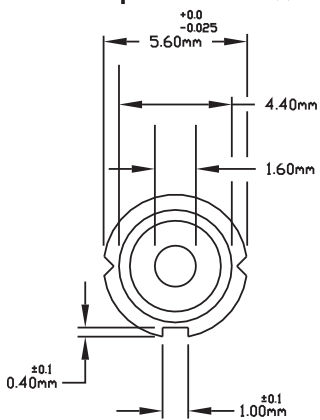

Side View

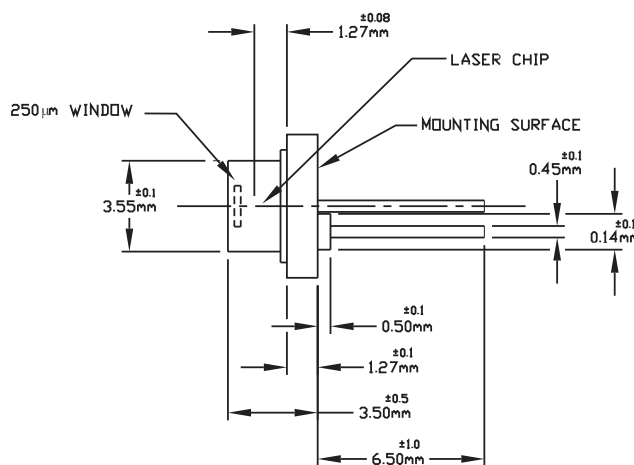

Bottom View

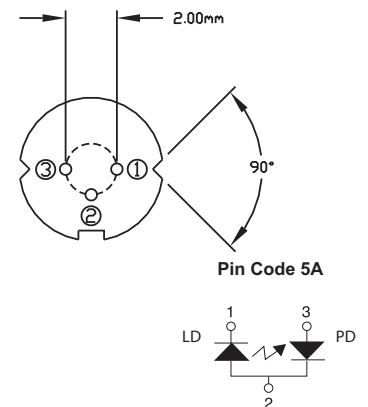

Pin Description

- 1 Laser Cathode
- 2 Case Common
- 3 Monitor Diode Anode

USA, Canada, & S. America
Thorlabs, Inc.
435 Route 206
Newton, NJ 07860, USA
Tel: 973-579-7227
Fax: 973-300-3600
www.thorlabs.com
email: feedback@thorlabs.com

Europe
Thorlabs GmbH
Hans-Böckler-Str. 6
85221 Dachau, Germany
Tel: +49-(0)8131-5956-0
Fax: +49-(0)8131-5956-99
www.thorlabs.com
email: Europe@thorlabs.com

UK and Ireland
Thorlabs LTD.
1 Saint Thomas Place, Ely
Cambridgeshire CB7 4EX, GB
Tel: +44 (0)1353-654440
Fax: +44 (0)1353-654444
www.thorlabs.com
email: sales.uk@thorlabs.com

Scandinavia
Thorlabs Sweden AB
Box 141 94
400 20 Göteborg, Sweden
Tel: +46-31-733-30-00
Fax: +46-31-703-40-45
www.thorlabs.com
email: scandinavia@thorlabs.com

Japan and Asia
Thorlabs Japan Inc.
5-17-1, Ohtsuka
Bunkyo-ku, Tokyo 112-0012, Japan
Tel: +81-3-5977-8401
Fax: +81-3-5977-8402
www.thorlabs.jp
email: sales@thorlabs.jp

